



Loudspeakers and Rooms for Multichannel Audio Reproduction

by
Floyd E. Toole
Vice President Acoustical Engineering
Harman International

Part 3 - Getting the Bass Right

Choosing the number and locations of subwoofers, and determining where to sit, are fundamental to good bass. Multichannel audio should be shared, so we try to get good bass at several locations. Acoustical knowledge is essential, but EQ can help.

The Rules for Good Sound in Rooms

At middle and high frequencies:

- ✓ Start with a loudspeaker that was designed to function well in a variety of different rooms.
- ✓ Use geometry, reflection, diffusion, and absorption to achieve good imaging and ambiance.

At low frequencies:

- Maximize the output from the subwoofer(s).
- Achieve a uniform performance over the listening area.
- Equalize to achieve good performance.

123

Solid Angle VLF Gains

| | |
|--------------------|----------------------------|
| 4π steradians | = full sphere = ref. level |
| | = suspended in free space |
| 2π steradians | = 1/2 sphere = +6dB SPL |
| | = on floor |
| π steradians | = 1/4 sphere = +12dB SPL |
| | = on floor against wall |
| $\pi/2$ steradians | = 1/8 sphere = +18dB SPL |
| | = on floor in corner |

124

So, we think that we know how to pick a good loudspeaker, and with some simple acoustical devices or smart design, we can avoid destructive reflections in a room. Now, what about low frequencies, the ones where the room is the dominant factor?

The first task is to locate the subwoofer where it radiates most effectively. Closed box or reflex (ported) woofers are pressure sources. It matters not which way the diaphragm faces because all such loudspeakers are omni-directional at low frequencies. Obviously, there needs to be ‘breathing’ space if we choose to face the diaphragm against a wall. And, if there is a port, don’t plug it!

However, where we place the woofer with respect to the adjacent room boundaries does matter. The least effective location is in the middle of a room. It gets better on the floor, still better on the floor against a wall, and best in a corner. This is “best” in the sense of maximizing the quantity of bass radiated into the room.

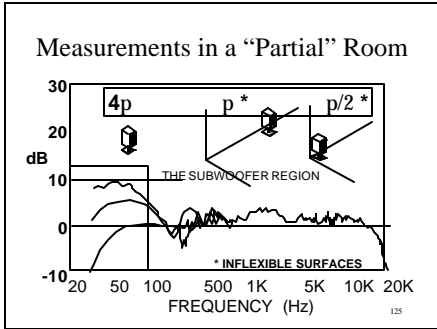

In theory we should be able to get huge gains from corner placement, and the test shown in the slide indicates that, if conditions are right, the gains are there. In real houses, the gains are a lot less, because of flexible room boundaries, open archways, etc. Still, even a 3 dB gain doubles the acoustical power into the room, and that is equivalent to adding a second woofer. Not bad, and it's free.

A Subwoofer in a Corner

- Produces the maximum possible LF output.
 - This is good
- Energizes all of the room modes
 - This can be good or bad, depending on the room, and how it is arranged.

CONCLUSION: Start with the sub in a corner, and move it only if necessary.

126

However, as they say, there is no free lunch. Corner locations excite every resonance in the room. This may or may not be bad. You will learn how to know the difference before we are through. If it is good for a particular room, then leave it alone and move on to the next problem. If not, find a better location. However, a corner is a logical starting location. For many simple installations, an unequalized single woofer in a corner can work very well indeed. In fact, I am listening right now to just such a system in my office/den.

The Rules for Good Sound in Rooms

At middle and high frequencies:

- ✓ Start with a loudspeaker that was designed to function well in a variety of different rooms.
- ✓ Use geometry, reflection, diffusion, and absorption to achieve good imaging and ambiance.

At low frequencies:

- ✓ Maximize the output from the subwoofer(s).

- Achieve a uniform performance over the listening area.

- Equalize to achieve good performance.

127

A multichannel audio system is intended to be a social experience, shared among several listeners. It is not like stereo, an antisocial experience, if it is to be heard properly.

We need to try to create a situation in which as many listeners as possible hear essentially the same sound.

The problem here is Standing Waves,
 Room Resonances, Room Modes,
 Eigentones, etc.

These are all the same phenomenon.

128

Most rooms “boom”. They have their own bass personalities. It is simply not possible to listen to the true bass output from a loudspeaker unless it is done in an anechoic space, and at very low frequencies, that means outdoors. What we hear indoors, also includes the room, and the positional factors within it.

Classes of Room Modes

- AXIAL: occurring between opposite parallel surfaces

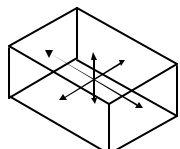

LENGTH

WIDTH

HEIGHT

129

Sound reflects back and forth between two parallel surfaces. At certain frequencies the incident and reflected sounds conspire to form “standing waves” in which those frequencies can be amplified, and what we hear at those frequencies depends on where we and the speakers are located. These are axial modes, since they exist along the major axes of the room.

Classes of Room Modes

- **TANGENTIAL**: occurring among four surfaces, avoiding two that are parallel

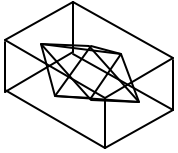

130

The cyclical reflected patterns can include two, four or more surfaces. If four are involved, we call them tangential modes. Since some sound is absorbed at each reflection, generally the tangential modes are less powerful than the axial modes, which include only two reflections per cycle.

Classes of Room Modes

- **OBLIQUE**: occurring among any and all surfaces

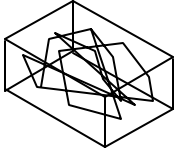

131

Oblique modes can involve any and all surfaces. They tend, therefore, to be the least important.

In Terms of Causing Audible Problems:

AXIAL MODES are the *dominant* factor!

TANGENTIAL MODES can be significant in rooms with very stiff/massive boundaries

OBLIQUE MODES are rarely, if ever, relevant

132

What is a Standing Wave?

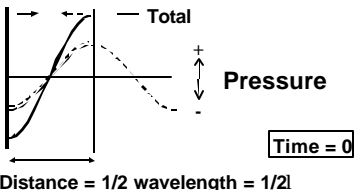

Distance = $1/2$ wavelength = $1/2\lambda$

Time = 0

133

The simplest of the standing waves, the axial modes, exist between two parallel reflecting surfaces. In this slide shown here, imagine that the two vertical lines represent walls in a room. Imagine a woofer against the left-hand one, radiating a pure tone – a sine wave – as shown. If the right wall were not present, the sine wave would simply propagate away. With the wall in place, the portion of the sine wave that would have moved on to the right is reflected back towards the source. The walls here are separated by exactly one-half wavelength, so the reflected sound wave is identical to the incident wave – they overlap perfectly. When added they make the “total” sound wave shown. Remember, this is a “stop action” view.

Standing Waves

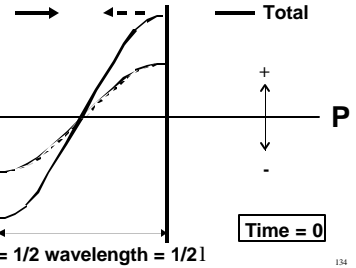

D = $1/2$ wavelength = $1/2\lambda$

Time = 0

134

Here is the same instant in time expanded in scale.

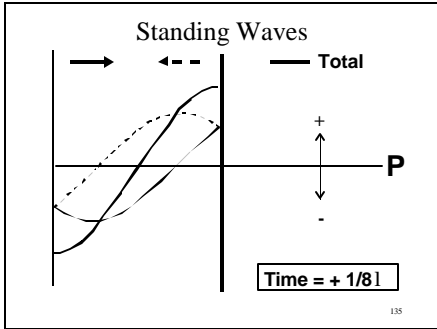

Here, we have done a very, very quick “play” and “pause”, stopping the action one-eighth of a wavelength later. Now the incident and reflected waves have different shapes, but the “total” is much the same, only a bit lower in amplitude. Interestingly it still crosses zero pressure half way between the walls.

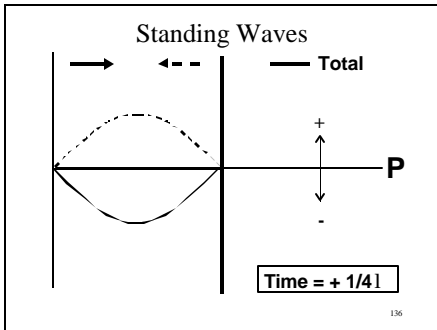

This is another $1/8$ wavelength later, or $1/4$ wavelength from where we started. The instantaneous sound pressure is zero everywhere.

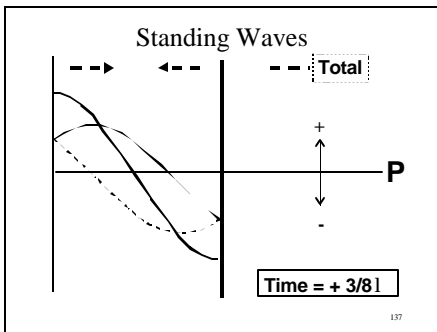

Moving on yet another $1/8$ wavelength, we note that the total waveform has “flipped” polarity, like a see-saw pivoting at the half-way point across the room. Still no sound at the mid point.

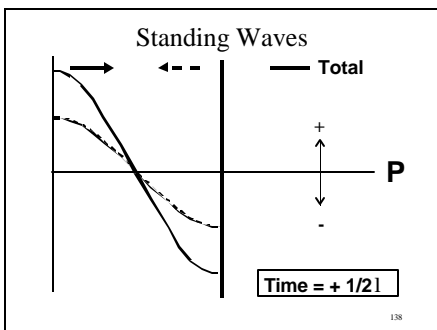

At the half-wave stop-action view, we are precisely in a situation that mirrors where we began. If we continued for the remaining half wave, we would end up where we started.

So, for the frequency at which the room dimension is precisely one-half wavelength, there will be a resonance, and a standing wave in which the sound pressure is always zero at the mid point between the reflecting surfaces. On either side the sound gets louder as one moves towards the walls. Note, that the instantaneous polarity of the pressure change is opposite on opposite sides of the pressure minimum, or null. This is important. Remember it.

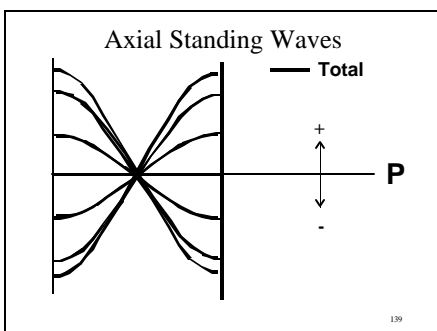

Here we see a superimposition of the stop-action “total” waveforms for one complete wavelength.

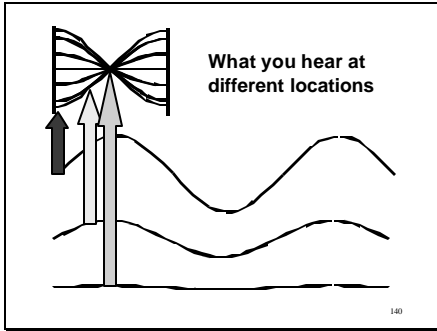

There is minimal sound at the mid point, and the sound gets louder as we move towards the walls.

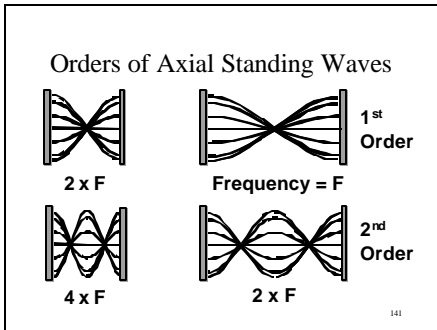

For a given distance between reflecting surfaces, the first resonance will be at the frequency having a wavelength equal to twice the separation. If the distance is halved, the frequency is doubled. There is also a second-order resonance, or standing wave, at exactly double the first frequency, and this standing wave has two nulls. There will also be third, fourth, and so on.

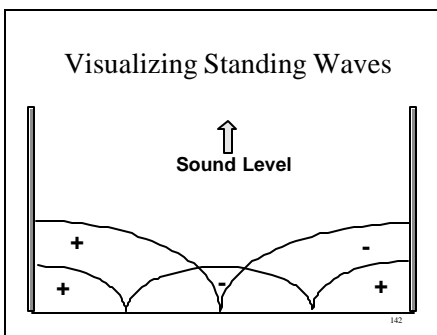

To visualize the standing waves, let us just plot the sound pressure as a function of distance, and remember that the polarity changes each time we cross a null.

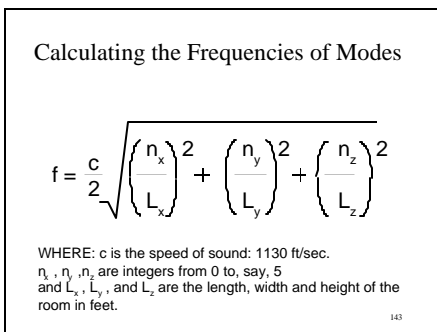

This formula allows us to calculate all of the possible resonances in a rectangular room. It is a bit frightening.

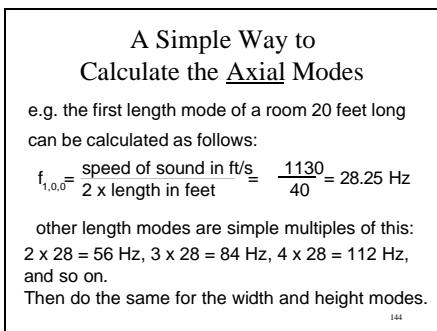

For the majority of situations, it may be sufficient to calculate only the axial modes. If so, it is very simple. Measure the room dimensions. Multiply the length by two, and divide it into 1130 (for dimensions in feet) or 345 (for dimensions in meters). This gives this first-order resonance along that dimension. Multiply that frequency by 2 for the second-order resonance, by 3 for the third-order, and so on. Usually it is necessary only to look at the first three or four orders. Now, repeat that for each of the other two dimensions.

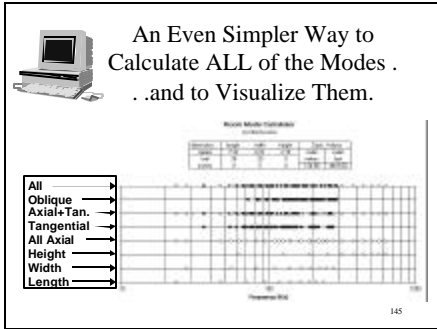

If you have a computer, it is all even easier. Just type in the dimensions, and the work is done for you. This is a little spreadsheet program that runs in Microsoft Excel for PC's that is available for download from www.harman.com in the section "white papers". It shows, in an easy to understand form, all of the modes in a rectangular room.

It has long been believed that, to be good, a room must have a uniform distribution of modes in the frequency domain. This is certainly true for reverberation chambers, where the notion originated. But, is it true for listening spaces???

146

But what about the "ideal" room?

The distribution of modes in the frequency domain is determined by the RATIO of the room dimensions:
 Height:Width:Length
 e.g. 1:1.5:2 = 8 x 12 x 16 feet

147

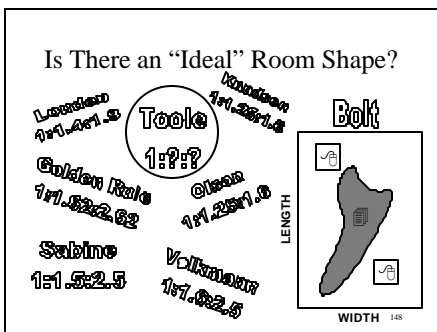

Over the years several acoustical luminaries have lent their names to room dimensions that purport to have advantages. Do I have a favorite too?

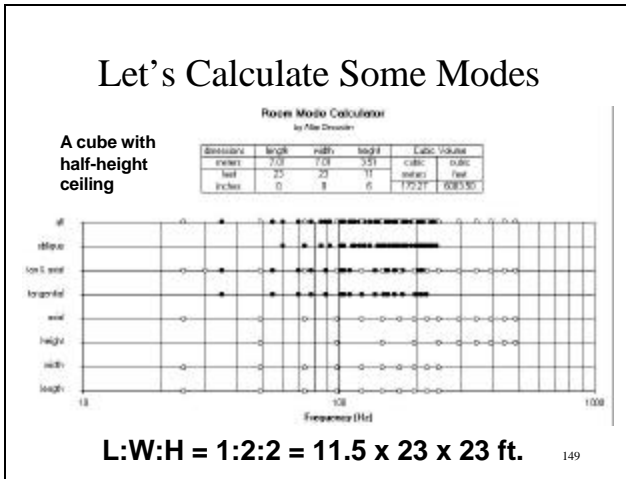

Everyone knows that a cube is the worst possible shape. Such a room is really impractical in any event, because the ceiling would be very high. Let's compromise, and make the ceiling height half of the other two dimensions. It can be seen that the room resonant frequencies all line up like little soldiers on parade, with big gaps between them. The suggestion is that some frequencies will be overly accentuated, and others not adequately represented. A room should be better if it had a more uniform distribution of resonant frequencies.

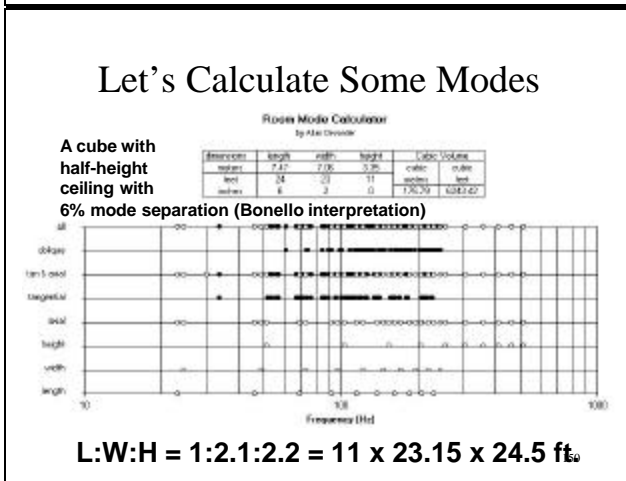

It has been suggested that adjusting the room dimensions to produce a slight separation of the resonant frequencies should help. Here, a recommendation of 6% separation of frequencies has been followed, and it is seen that while the high frequencies appear to be improved, the low frequency resonances are still in closely-spaced groups with large gaps.

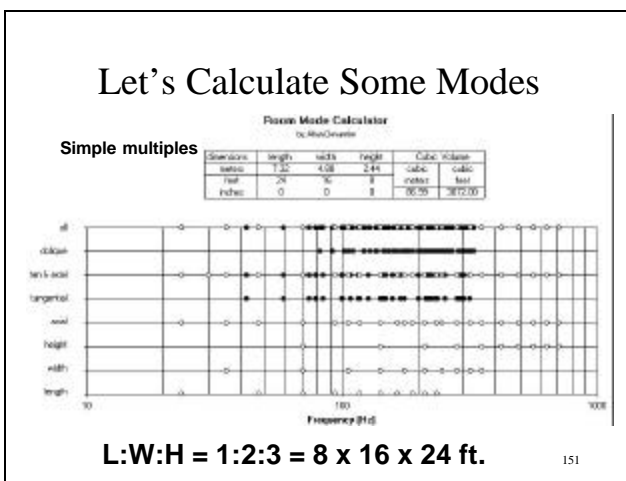

A room with dimensions that are simple multiples of each other produces a mixed situation. Some of the modes seem to be well separated, but others line up at certain frequencies.

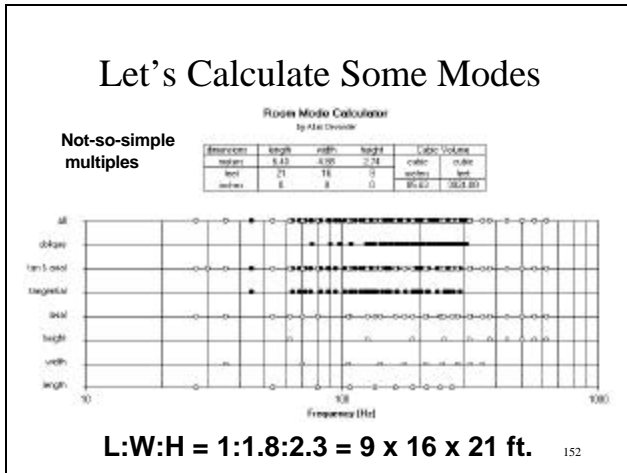

Just departing from simple multiples seems to do wonders. Here the modes all seem to be quite well distributed. If this approach to room design has any merit, this room should have some audible advantages. Does it?

This all makes a very nice story, but does it really matter?

Maybe . . . Somewhat . . . It all depends . . .

Oh, all right,
No!

153

Why not?

- The calculations assume that all of the modes are equally energized by the loudspeakers – they are not.
- The calculations assume that all of the modes are equally heard by the listener(s) – they are not.
- The only modes that matter, are those that are involved in the transfer of sound energy from the loudspeakers to the listener(s).

So, how do we determine that?

154

The simplifying assumptions underlying these predictions make them simpler, but also simply invalidate them!

Important Facts About Woofers, Listeners and Standing Waves.

- Conventional woofers are *sound pressure* generators. They will “couple” to the room modes when they are located in *high pressure regions* of the standing waves.
- Ears respond to *sound pressure*, therefore, room modes will be most audible when our heads are located in the *high pressure regions* of the standing waves.

155

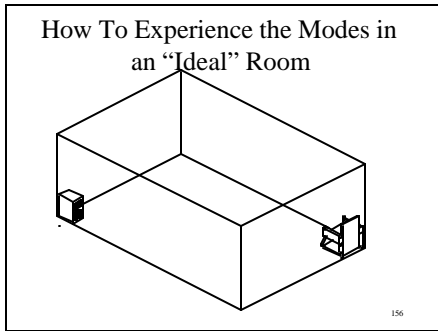

In order to hear the benefits of a room with "ideal" proportions, this is how it would need to be arranged. The ideal proportions were determined by looking at the distribution of all the resonances, so we need to energize them all. A woofer on the floor in one corner excites all of the room resonances. Likewise, the listener must sit with his head stuck in another corner, in order to hear all of the modes.

This sounds silly, but it is true.

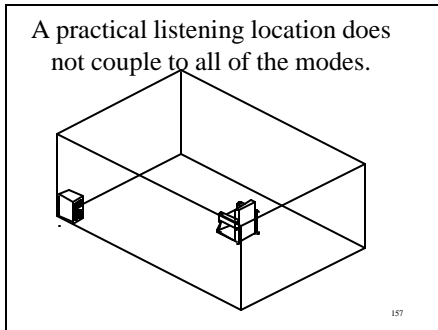

Of course, in practice, we don't do this. We sit where we want to.

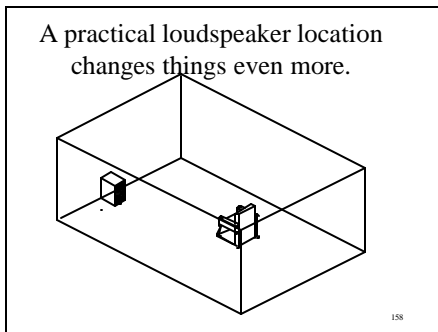

And we place our loudspeakers where they need to go for good imaging.

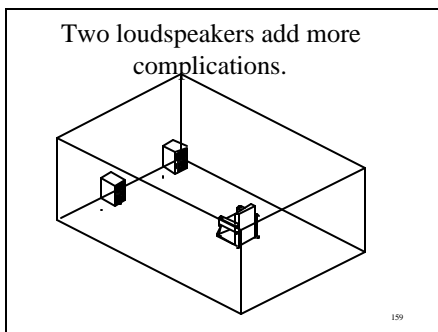

And we listen in stereo.

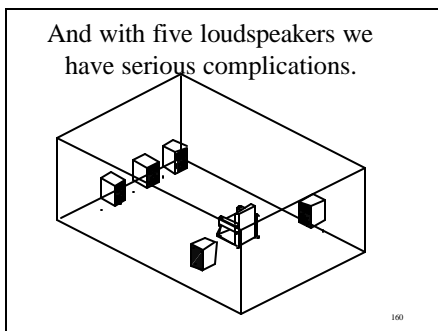

If not in a multichannel format. All of those neat calculations don't mean a thing in a situation like this! They are just an academic exercise, more window dressing.

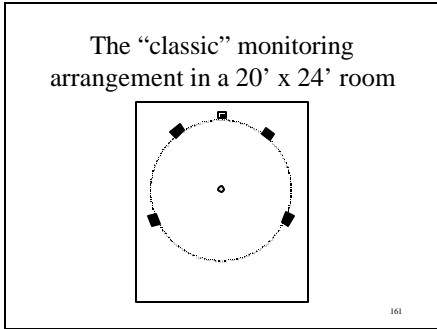

Here is how some professionals listen, with five full range loudspeakers located according to the new European standard: center, +/- 30° and +/- 110°.

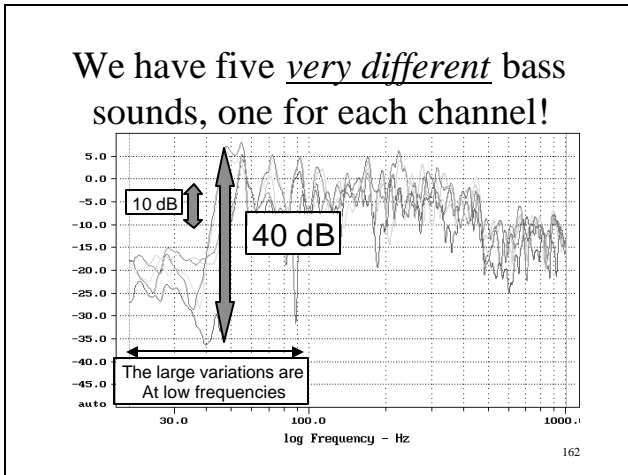

When a full-range signal is panned to each of the loudspeakers in turn, and measurements are made at the listening position, we find hugely different bass responses for each of the loudspeakers. The differences are as large as 40dB in this room, and the biggest ones are all at low frequencies. The reason, the woofers each have very different acoustical "coupling" to the room resonances because they are in different locations. This will be different for every different room. Again, referring back to the "circle of confusion" the bass that was heard in the control room will not be the same as that heard at home. It cannot be.

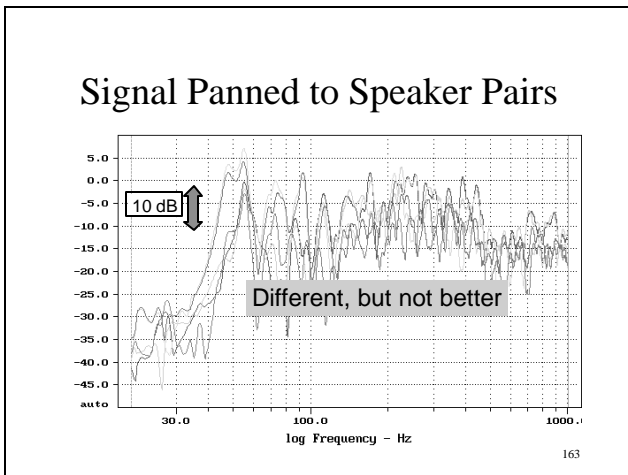

Attempting to improve the situation by panning the bass to pairs of loudspeakers changes things, but does not remove the problem.

Anybody think that an "ideal" room can help this? An anechoic room would, but none of us would wish to live in one.

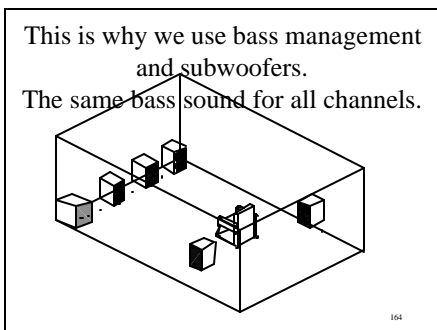

And this is why bass management and subwoofers make sense. Now we can place the woofers where they perform optimally for a specific room with a specific listening position. We can place the satellites (a term that seems inappropriate for some of the large capable loudspeakers that we use in the high-passed channels) where they need to be for directional and imaging effects. In other words, we design the low-frequency portion of the system separately because rooms force us to do so. This is the only way that we can get good bass in any room, and have any hope of having similarly good bass in different rooms. Remember about preserving the art?

How many subwoofers?
 Where do we put them?

 Where do we sit?

165

More than one subwoofer may be needed for high sound levels in large listening spaces. It's physics. One huge box might be difficult to hide, while a number of smaller ones might be less conspicuous. But there are other considerations which become obvious as soon as we start looking in detail at room resonances.

'Fast' and 'Slow' Woofers.

A digression here about the "speed" of woofers. I keep on hearing stories that small woofers are "faster" than big ones. Well, there is truth in the argument if you consider the highest frequencies they are capable of reproducing. However, if we are crossing them over at 80 Hz, for example, to use them as subwoofers, we have limited that highest frequency to be the same for all. They are then all equally "fast". Woofers are minimum-phase devices (see Part 2). Their time-domain behavior – speed, punch, drive, pace and rhythm - can be anticipated from their frequency responses. We will soon see that rooms really mess this up and determine what we hear. As for moving mass, we use bigger motors on larger, heavier, diaphragms. It's a "horsepower thing".

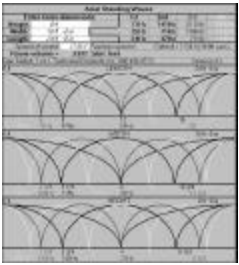

A Standing
Wave
Calculator

166

Understanding what happens in rooms at low frequencies requires knowledge of what the standing waves, or resonances, are doing to us. Part of the Excel program mentioned earlier is a great help. It shows the pressure distributions for the first few axial modes along each of the room dimensions. It is available for download from www.harman.com under "white papers".

**Woofer Location Decides How
 Much Energy Each Mode Receives.**

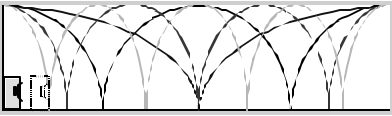

A woofer on the floor, against a wall, energizes all modes along that axis.
 What happens if we move it forward, say, to the first pressure null?

167

Here I show a woofer placed against a wall, where it excites all of the modes along the length of the room. Why? Because it is in a high-pressure region for all of the modes. What happens if we move the woofer forward, to the location of the first pressure minimum?

**Woofer Location Decides How
 Much Energy Each Mode Receives.**

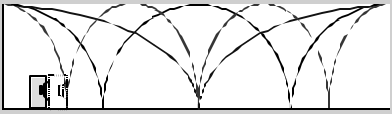

A pressure source located at a pressure null, or minimum, does not energize that mode.
 What happens if we move it forward to the second null?

168

That particular mode is not energized by the woofer, and it disappears. What then happens if it is moved further ahead to the next null?

Woofer Location Decides How Much Energy Each Mode Receives.

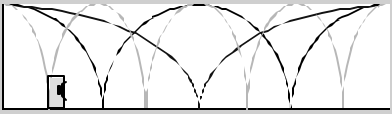

A pressure source located at a pressure null, or minimum, does not energize that mode. Note that it is the woofer diaphragm that is the pressure source, not the whole enclosure.

169

That mode ceases to be activated, but the other one returns. Woofer location determines which of the room resonances is activated, and which is not.

Similarly, the Listener Location Determines Which Modes Will Be Heard.

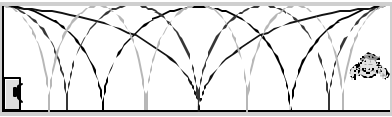

↑ A woofer on the floor, against a wall, energizes all modes along that axis. ↑
 A listener against the opposite wall, hears all modes along that axis. There may be too much bass.

170

Just as a woofer against a wall energizes all of the standing waves in that dimension, a listener with his head close to the opposite wall hears all of the modes. Just as a woofer against a wall enjoys a gain in output because of the adjacent boundary, so the ears enjoy a similar low-frequency gain. There will be too much bass!!

Similarly, the Listener Location Determines Which Modes Will Be Heard.

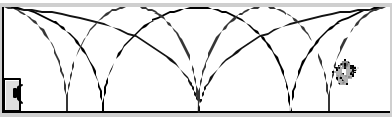

↑
 For this listener, the bass is in better overall balance, but he wonders what happened to one of the bass notes.

171

Moving the listener forward provokes the same problem we had when moving the loudspeaker forward. If the head is at a null, no sound will be heard from that mode.

Similarly, the Listener Location Determines Which Modes Will Be Heard.

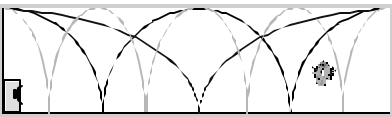

↑
 And here, it is a different note that has disappeared.

172

Different positions mean that different frequencies will be heard with sometimes very different loudness.

Similarly, the Listener Location Determines Which Modes Will Be Heard.

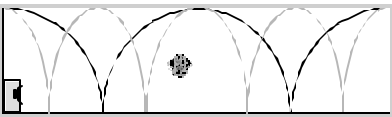

↑
 And here, two of the best really low frequencies have gone away.

173

Similarly, the Listener Location
Determines Which Modes Will Be
Heard.

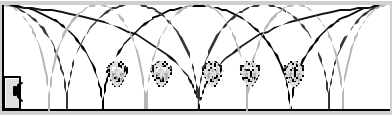

But, there are several locations where happiness might be possible.

174

The diagram shows a rectangular room with a speaker on the left wall. Several curved lines represent acoustic modes. A single listener icon is positioned in the center of the room, with lines indicating the sound path from the speaker to the listener.

However, there are locations that might work reasonably well.

Similarly, the Listener Location
Determines Which Modes Will Be
Heard.



These are also suitable locations for loudspeakers, but not all are practical, just as not all listener locations are practical.

175

The diagram shows the same rectangular room with a speaker on the left wall. Multiple listener icons are positioned at various points along the front wall, with lines indicating the sound path from the speaker to each listener.

And this is true for woofers as well as listeners.

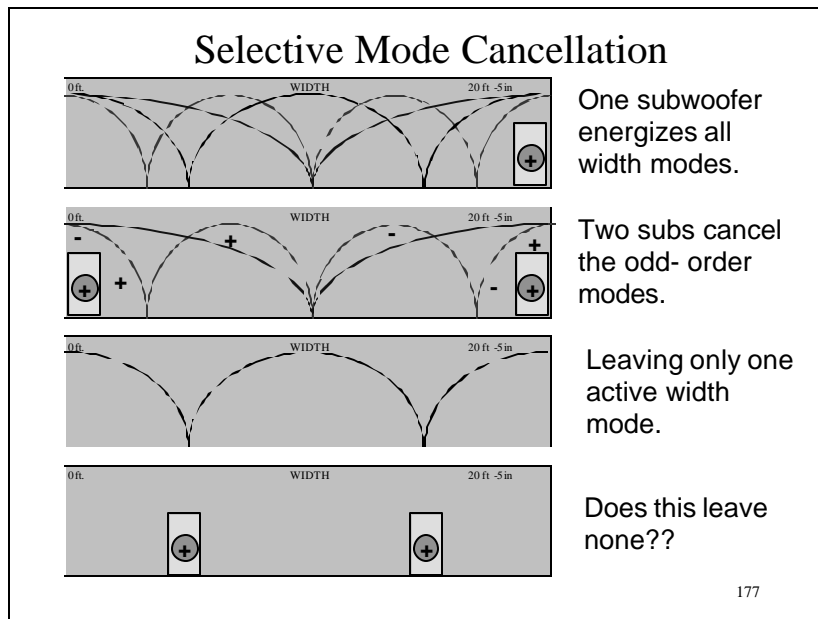

Here we get a bit fancy. Remember the standing wave diagrams showing the “see saw” behavior of the waveform pivoting on a null. It means that at any instant in time, the sound pressures on opposite sides of a null in a standing wave are in opposite polarity. If one side is increasing, the other will be decreasing. None of this matters if we have only one source of low frequency energy in a room. However, if we have two or more, things get complicated. The top picture shows all of the width modes in a room being excited by a single subwoofer. If we place another in a symmetrical position on the other side of the room, the woofers, which receive exactly the same signal, are operating in phase (the same polarity) with each other. The first- and third- order modes, however, exhibit opposite polarities at the subwoofer locations – see the opposite polarity signs. What happens? The subwoofers couple in a destructive manner with the odd-order modes, and those modes are simply not energized. They do not exist. This leaves only one mode across the width of the room. If we get even more clever, and move the subwoofers to the null locations for that mode. They are still in opposite polarity regions for the odd-order modes, and the result is that all of the width modes are significantly attenuated, if not eliminated. Magic, no. Science, yes.

So, why would we want to do this? Aha! Would it not be a good idea for everybody in each row of a home theater to hear the same bass sounds? Would it not be a good idea for a recording engineer to be able to move from one end of the console to the other without experiencing huge changes in bass? Well, this is how it can be accomplished. We are not saying, yet, that it is good sound, merely that it is the same sound. Once things are equalized in the sense of getting everybody hearing more or less the same sound, we then may need to equalize in the sense of changing the frequency response of the system.

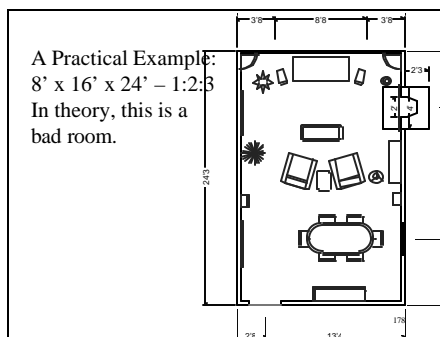

Just to prove a point, let us take a real example: a room that, by most advice should be a bad room. It is not an unusual situation. There is a living/dining room, with a rear projection television at one end, seats in the middle area, and a dining area behind the chairs.



It looks normal, and could happen in a detached dwelling or in an apartment.

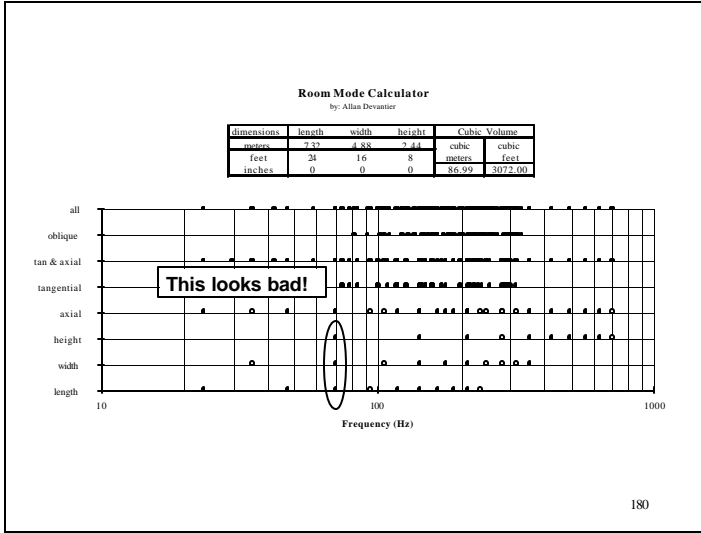

The modal distribution shows that there could be a problem with three modes stacking up at 70 Hz.

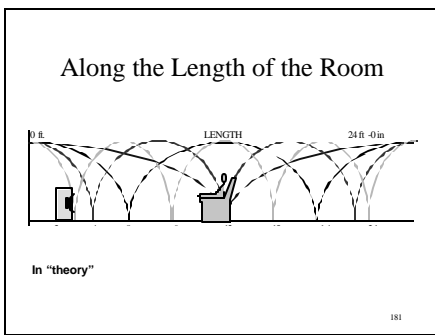

Fortunately, we have some help from the locations of loudspeakers and listeners. The loudspeakers are lined up with the front of the RPTV, and that puts them in the null of the fourth-order mode. The listeners are seated at the mid point, and they are in the nulls of the first- and third-order modes.

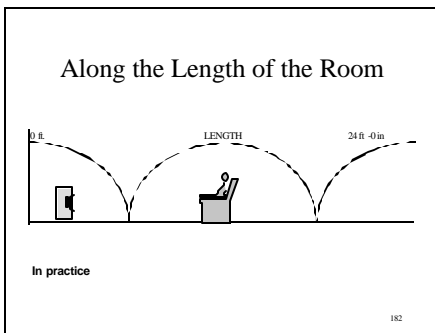

That leaves only the second-order length mode to cause problems.

Across the Width of the Room

In "theory"

184

In theory there are a bunch of modes at play.

Across the Width of the Room

In practice – the loudspeakers, which operate 'in phase' at low frequencies, "destructively" drive the 1st and 3rd order modes (they are not energized), and they are located at the nulls of the 2nd order mode (it is not energized). The 4th order width mode is "constructively" driven.

185

In practice, we have selected locations for the loudspeakers and listeners that avoid them all.

Across the Width of the Room

But, the listeners are located at nulls of the 4th order mode and it is not heard.

186

Across the Width of the Room

So, in practice, there are no active width modes in the listening path.

187

Room Mode Calculator

By: *Richard Dobson*

| Room Type | Length (ft) | Width (ft) | Height (ft) | Volume (cu ft) | Surface Area (sq ft) |
|-------------|-------------|------------|-------------|----------------|----------------------|
| Rectangular | 12.0 | 12.0 | 8.0 | 1152.0 | 432.0 |
| Circular | 12.0 | 12.0 | 8.0 | 1152.0 | 432.0 |
| Spherical | 12.0 | 12.0 | 8.0 | 1152.0 | 432.0 |

188

The modal distribution looks a lot less cluttered after we cross off all of the modes that are not involved with communicating between the woofers and the listeners in those chairs. Remember, things will be different elsewhere in the room.

And, finally, the height dimension

In practice: the ears are close to the nulls for the 1st and 3rd order modes. They are not eliminated, but are seriously attenuated.

189

Room Mode Calculator

| Dimension | Length | Width | Height | Volume | Units |
|-----------|--------|-------|--------|--------|-------|
| Room | 11.2 | 11.2 | 7.4 | 930 | cu ft |
| Room | 3.4 | 3.4 | 2.2 | 25 | cu ft |

What problem?

This one might be a problem because it is so lonely. 47 Hz, let's have a look.

When we are through, there is only one solitary room resonance that is actively involved in the acoustical link from the loudspeakers to the listeners. Amazing!

Let's measure it and see what we have.

And guess what we found?

80 Hz crossover

3 coincident nulls

47 Hz!

191

Surprise, surprise. There is a resonance at 47 Hz, the frequency of the remaining second-order length mode. And, guess what, there is a sharp dip at 70 Hz, just where we successfully canceled those problematic modes. To get rid of the dip, all we need to do is to be less successful at canceling some of those modes. In other words, move a chair or a loudspeaker a few inches.

A simple fix

BEFORE and AFTER one band of parametric EQ

192

And, what about the resonant peak? When we listened, it was clearly audible, making kick drums “boom”, and all bass inarticulate and floppy. All bass tended to be “one note bass”, the “tunes” in the bass guitar were all but gone. We could have blamed the woofers, accusing them of being slow, uncontrolled, and tuneless. But we know better.

The solution? Because the room resonance is a minimum-phase phenomenon, we designed a parametric filter to attenuate the peak, and the system is instantly transformed. The bass was tight, the guitars played tunes at low frequencies, explosions no longer had a pitch. The room sounded great.

The Problem and Solution in the Time Domain

BEFORE and AFTER one band of parametric EQ

193

The long ringing of the original room is transformed into a well damped, tight, transient response. It works. The woofers were ‘fast’ all along. We just couldn't hear it.

So, according to dimensional ratio theory, this was supposed to be a bad room. In this practical example, it ended up having only **one** problem resonance and, after equalization, it yielded truly superb sound!
 Good Sound in a “Bad” Room!

O.K. So this is showing off. However, it does prove a point. If you understand basic room acoustics, have some decent analytical tools at your disposal, including measurements, most rooms can be under control.

Not all stories have such a happy ending, but happy endings are unlikely unless the loudspeaker and listener locations are evaluated in conjunction with the standing wave patterns.

REMEMBER:
The only modes that matter are those that participate in the communication of sound from the loudspeaker to the listener!
 and
There is NO ‘ideal’ room!

So, back to the issue of “ideal” room dimensional ratios. Personally I have no favorites. I have yet to encounter a room that could not be made to sound at least good, if not excellent.

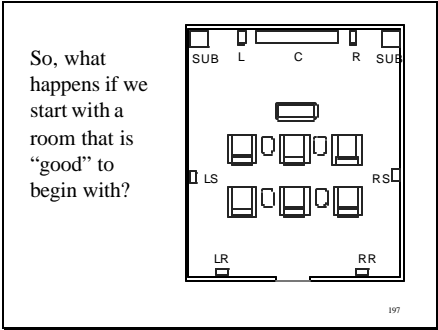

In this example we will really make use of acoustical measurements. It will be seen that high-resolution (better than 1/3 octave) measurements allow us to confirm which resonances are active in which parts of the room. They will allow us to experiment, intelligently, with subwoofer and listener locations. In short, good measurements put us in control. We may or may not achieve our fantasy performance, but we certainly can get closer than would be possible by trial and error.

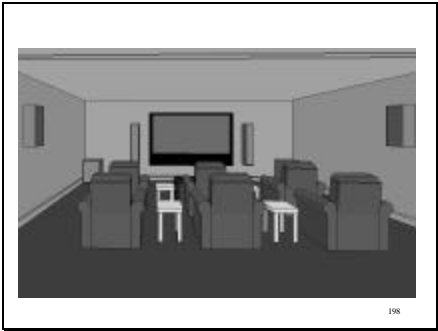

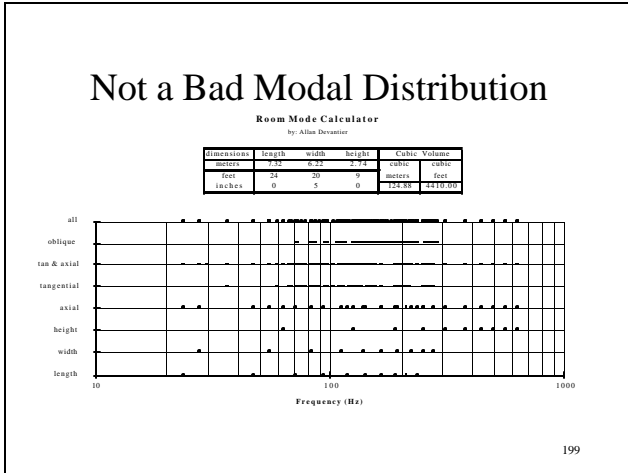

According to common belief, this room should have some advantages, because of the favorable distribution of modes.

However, taking nothing for granted, let's actually measure what is happening at different listening locations, when we employ one or two subwoofers.

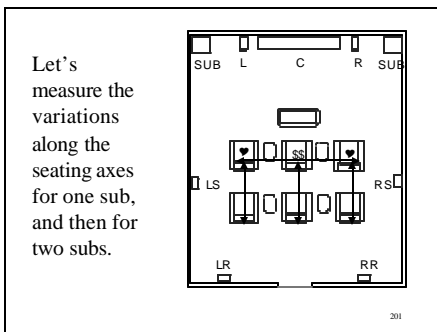

It is obviously important to keep the customer and the family or close friends happy, so pay attention to the front row. I think it is natural to expect the best of everything in the front row. Measurements are made at 18-inch intervals across the front row, and from each of the seats to the rear. Note, first of all, in the slide below, that it is possible to identify many of the axial modes calculated for this room. The frequencies don't always line up exactly, and this will be explained later.

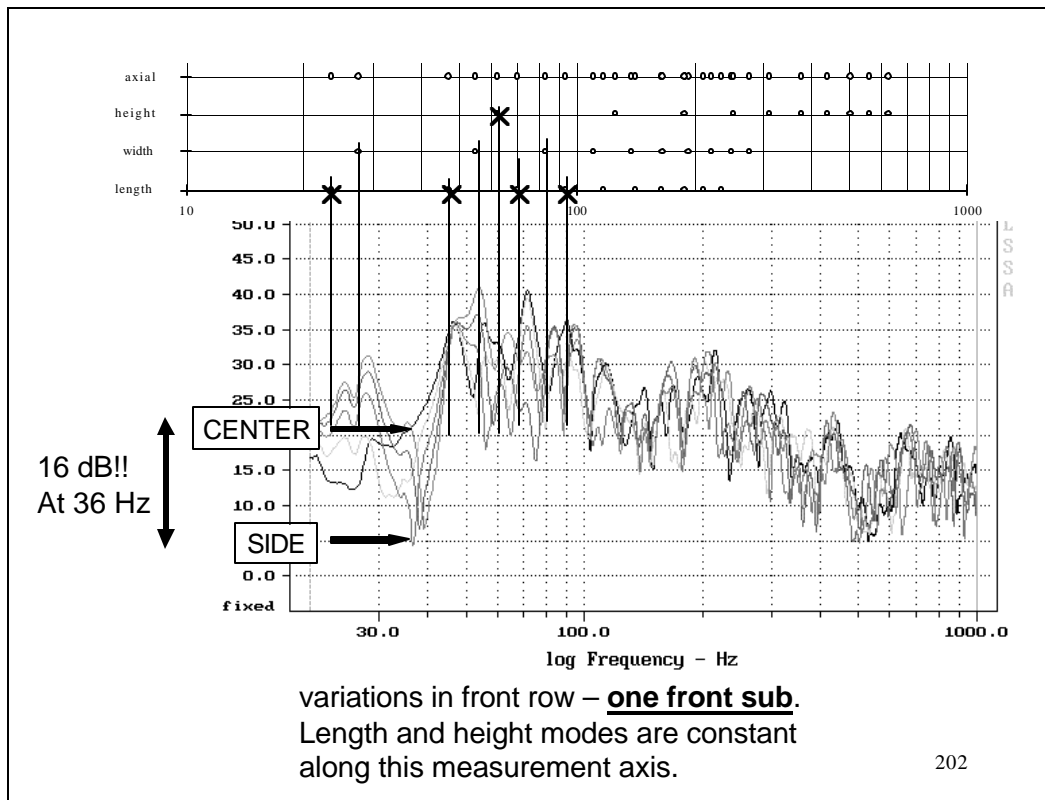

The above graph shows, in detail, what happens at 18-inch intervals across the front row. Because the room is symmetrical, what we are really looking at is what happens from the center seat to the side seats. It can be seen that there is a 16 dB difference around 36 Hz between the center and the side seats. This is huge, and this is a very important part of the frequency range. It could be that the host, sitting in the center, exclaims to his buddy, to whom he is showing off the system, “listen to that fantastic bass!”. The buddy, sitting beside him, could be justifiably underwhelmed if the bass frequencies fall into this range.

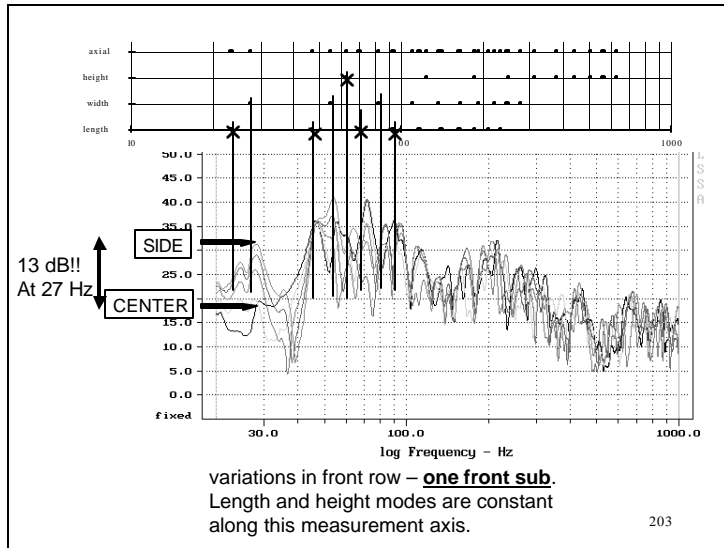

Later in the same movie, there is a thunder storm, and the almost-subsonic rumble is perceived by the guest to be just stunning, but the host thinks it is just O.K.

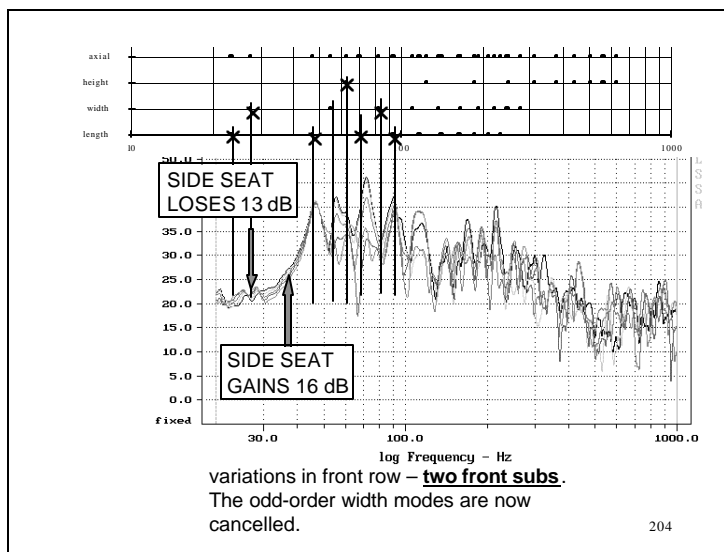

This is where mode canceling can be useful. Using a pair of subwoofers, the problematic width modes are cancelled, and the bass is rendered uniform across the front row up to about 55 Hz. There is a trade-off. We sacrifice some of the deepest sounds in the side seats, but we pick up 16 dB of the more important frequencies higher up, around 36 Hz. The recommendation is, therefore, to use two subwoofers located opposite each other across the front of the room. The bass response is still uneven, but we have managed to make it more uniform across the all-important front row of seats.

The pair of subs will not only deal with the front row, but will also make performance across the back row more uniform. However, as it is set up, the front and back rows will hear different bass sounds. A decision must be made of how to equalize, if that route is chosen. Normally, priority is given to the front row

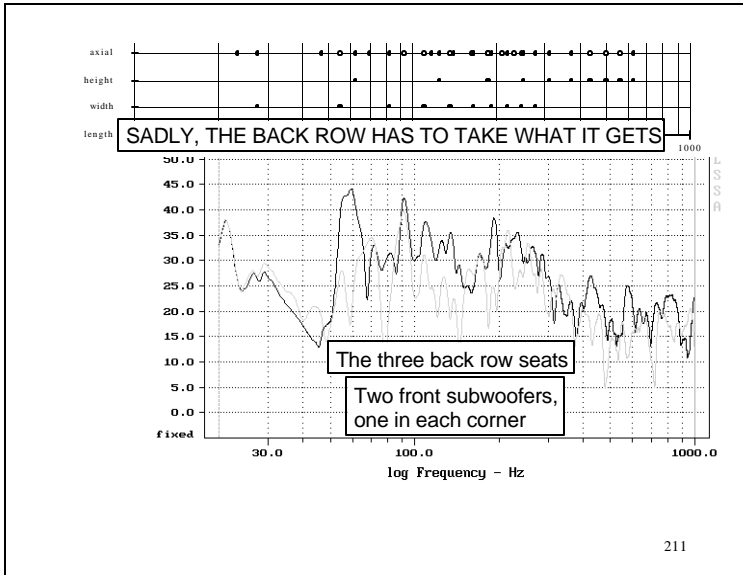
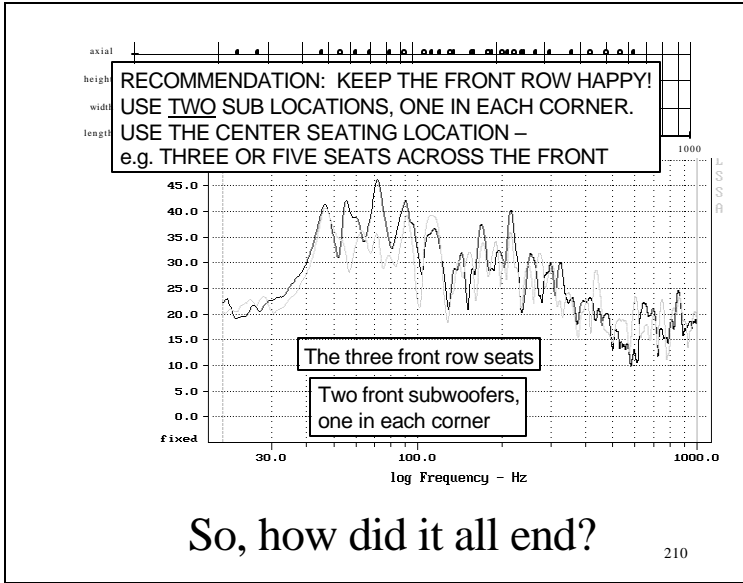

Now, let us look at a smaller room – 24 x 16 x 9, with 2” x 6” studs, and two layers of 5/8” gypsum board. i.e. heavy, stiff walls.

215

As stated earlier, heavy, stiff walls absorb little energy at low frequencies. This helps to keep the bass energy inside the room, and the poorly-damped standing waves will exhibit strong high-Q peaks and dips, and ring energetically. Also, the reduced absorption at each reflection means that tangential modes may join the axial modes as being factors to deal with.

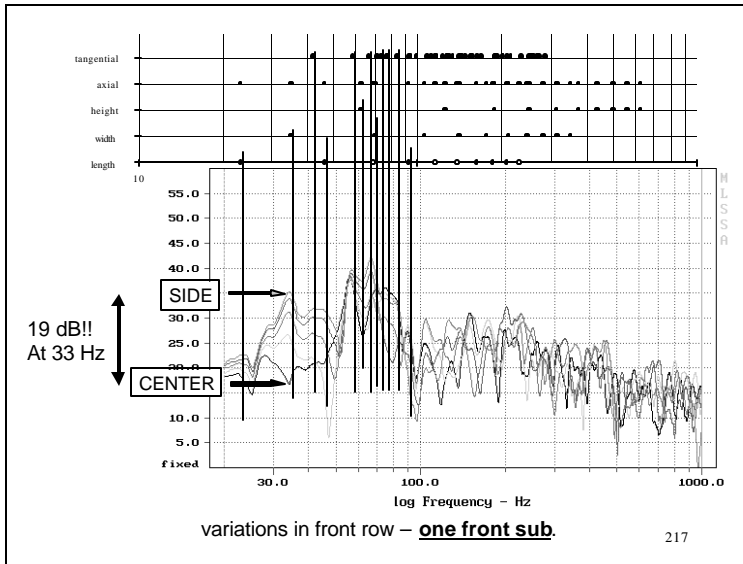

In this room, it is clear that the tangential modes are very active. Note that it is possible to identify almost all of the axial and tangential modes in the visible peaks at low frequencies. Moving across the front row produces a rather large 19 dB variation from center to side seats over a very important part of the bass frequency range. It would be nice to reduce this.

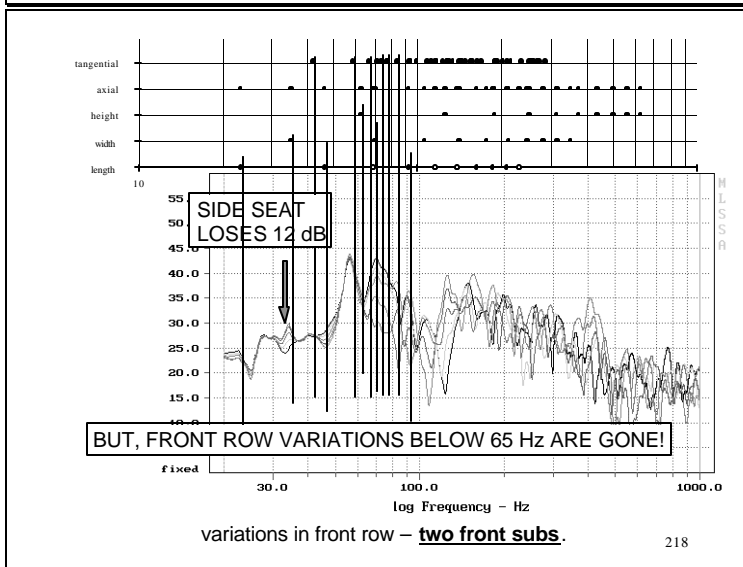

Employing the tactic used in the previous example, two subs, one in each front corner, we certainly get consistent performance across the front row, but we have sacrificed a lot of good bass in the process.

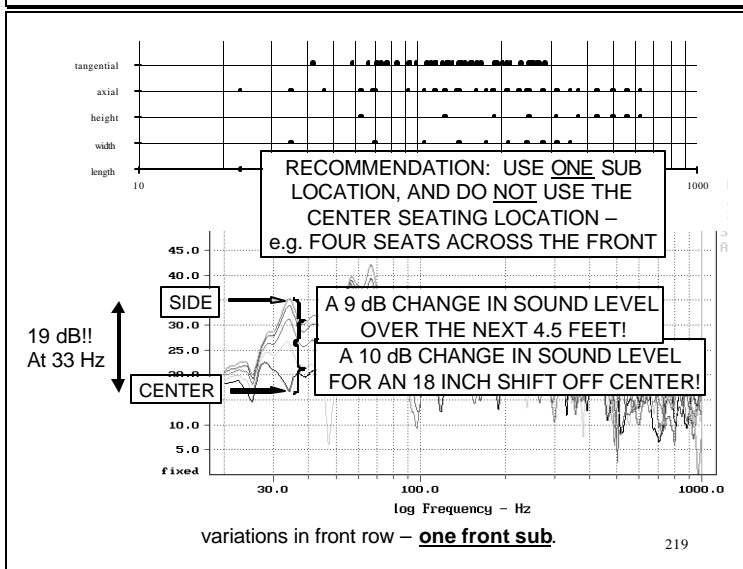

Looking closer, we notice that 10 of the 19 dB change occurs in the first 18 inches away from the center location. This is a high-Q null. The remaining 9 dB accumulate over the next 4.5 feet. Taking advantage of this knowledge, we decide to go back to one subwoofer location – we may in fact use two subs stacked at that location, to get enough power into the room. We avoid the center seating location, choosing to arrange the chairs symmetrically around the room center line. None of this would be obvious without measurements – good measurements, and enough of them to help design the best listening experience for the circumstances.

Some Observations

- You cannot escape from room modes!
- ONLY high resolution measurements can help you understand what is happening. 1/3 octave not enough.
- Mode control with multiple subs is very position dependent, but it can work IN CERTAIN ROOMS.
- Massive, rigid walls make the situation much more complicated by activating tangential modes.
- Spatial averaging of measurements is essential to address the needs of an audience.
- You will never satisfy everybody in the audience.

220

But, You Have Heard That Non-Parallel Walls Solve all of These Problems.

221

What About Non-Parallel Walls?

- The modes are not eliminated
- The strength of the modes is much the same as in a rectangular room
- Because of the complexity of the standing waves, predictions of pressure distributions are not easy, and may not be practical.
- Why bother?

222

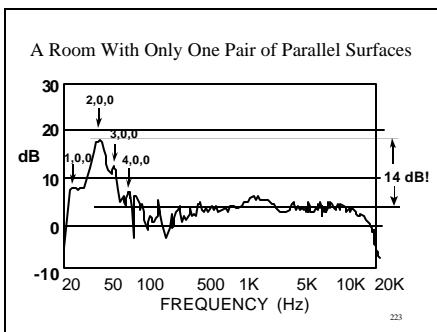

Here is an example of a room that had only one pair of parallel walls. The high ceiling was sharply angled, about 40 degrees. The side walls had several large openings, recesses, and a large stairwell. There was hardly any parallel surface left that was at a fixed spacing from one across the room. Taking a simple look at the room, it should have some advantages. But, the bass in that room was awful. It boomed horrendously. I know, because it was in my last house. When measured, it revealed a set of very clear resonances, all of them associated with the remaining pair of parallel walls. With no competition from any other modes, these ones sang their little hearts out.

Sound Absorption reduces the energy in the modes. This is called DAMPING.

224

By removing energy from the modes using damping at the reflecting surfaces, it is possible to attenuate the high-pressure regions of standing waves, and to elevate the low-pressure regions. Doing this makes the sound field less variable over the room. In my opinion, this is where we should start, preferably when the room is being built.

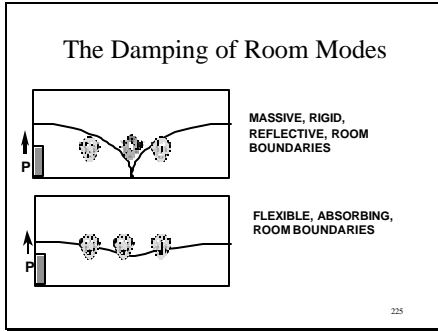

Less variation means more happy listeners.

Acoustical Damping of a Mode:
 (a) using *resistive absorbers*, e.g. fiberglass, acoustic foam, drapes

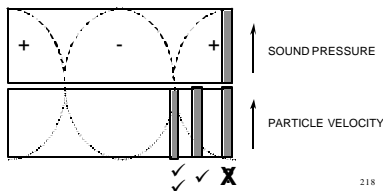

Sound absorption can be achieved with resistive absorbing materials, like fiberglass, acoustic foam, heavy drapes, etc. However, to be effective these materials must be in the regions of high particle velocity. This does not happen immediately at the room boundary, because, by definition, there can be no particle movement when the molecules are hard against a rigid surface. Maximum particle motion occurs in regions of minimum pressure – at the nulls in the standing wave pattern, one-quarter wavelength from the reflecting surface. So, one either needs thicker material, or some air space behind the material. Thicker material works better, but is costly. Either way we face using a lot of space.

Resistive absorbers are most effective when positioned in the high *velocity* regions of the standing wave

227

Dropped ceilings, the T-bar systems with lay-in panels actually work well at low frequencies because of the large space above them. The panels themselves, if placed on a hard surface, are no better than the equivalent thickness of rigid fiberglass board purchased from a building supplier. Be careful not to let such ceiling systems buzz or rattle, though.

Resistive Absorbers are not Practical at Low Frequencies

- 1/4 wavelength at 100 Hz = 2.8 ft.
- 1/4 wavelength at 50 Hz = 5.7 ft.
- 1/4 wavelength at 30 Hz = 9.4 ft.

228

“Bass Traps” are a favorite topic in pro audio. The name conjures an image of a device that seeks out and sucks up bass, never to spit it out. Well, reality is much less romantic, and real bass absorbers are only as effective as space and the budget permit.

If we try to damp really low frequency resonances with resistive absorbing materials, success is possible only if serious amounts of real estate are devoted to the task!

Want to Build a “Bass Trap” with Fiberglass?

Be my guest!

229

This should be a real stimulus to the building industry, if every home theater had to be about 20% larger in every dimension. Remember, to absorb energy in the modes in all directions, one of these appendages must be built on the ceiling, and another on a side wall. Cost conscious customers might wonder if there is a better way. There is.

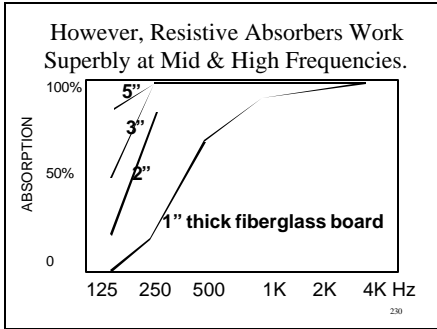

However, at higher frequencies, where wavelengths are shorter, such materials work just fine, and are highly recommended. Just don't cover them with a non-porous material, because such materials need to "breathe". Resistive absorbers do their work by making it difficult for the air molecules to move around within the "fibrous tangle". A good low-cost covering, available in a wide range of colors, is polyester double-knit, often used for speaker grilles. If the covering needs to be fire rated, look elsewhere, and pay much more.

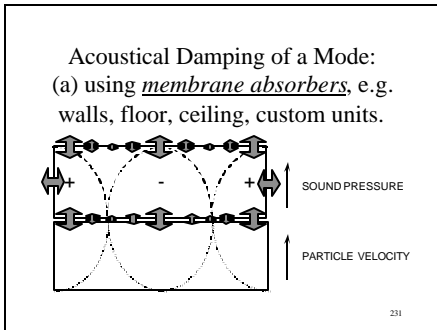

At very low frequencies, we need another technique. It is membrane, or diaphragmatic, absorption. In this, the fluctuating sound pressure of sound causes a surface to move, and in doing so, transfers energy to the moving surface. So, when you feel the bass in your feet, or feel vibrations in the walls, you are experiencing membrane absorption. Obviously, the best location for a membrane absorber is in a high-pressure region for the problem mode. If the room is constructed with bass absorption in mind, the problem is diminished from the outset. "Let the boundaries move" could become a mantra for enlightened room design.

Membrane (mechanically resonant) absorbers are most effective when located in the high *pressure* regions of the standing wave pattern.

The room boundaries do it naturally.

224

Mechanically Resonant Membrane Absorbers

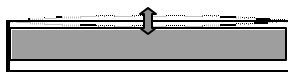

The resonant frequency is determined by the moving mass of the exposed panel, and the compliance of the air inside the enclosure (the volume/depth). A heavier panel, or a deeper box, reduces the frequency. Damping is achieved by mechanical losses in the panel material, and by acoustical losses in the fiberglass. Lossy, "soft" panels have low-Q, i.e. absorption over a wide frequency range. Heavy vinyl has been used successfully.

225

Commercial membrane absorbers are available. Most are flat, and fit against the room boundaries. Others are designed to fit in corners, or to stand freely. Be sure to check that they exhibit high absorption coefficients at the frequencies you wish to damp. Some of them work well at lower mid frequencies, but lose it in the deep bass region. Ironically, a single layer of wallboard on standard studs does a decent job. Things get problematic when a second layer of wallboard is added, or bigger studs are used, or the wall is filled with sand, etc. A somewhat compliant inner surface to a room is a generally good idea. "Let the boundaries move." Mind you, a wall or ceiling that rattles and buzzes is not welcome. So pay attention to how it is constructed.

Acoustically Resonant "Helmholtz" Absorbers

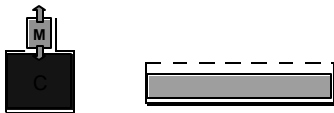

In a "classic" resonator the resonant frequency is determined by the mass of the air in the neck, and the compliance of the air in the chamber (volume). This is the "soda bottle" resonance.

This can be expanded into a surface, with the resonant frequency being determined by the mass of the air in the slots between the bars, and the compliance of the air in the cavity behind. Some fiberglass in the cavity provides damping.

226

A second kind of low-frequency absorber involves a tuned acoustical resonance. Usually these utilize slats with spaces between, and a damped volume behind.

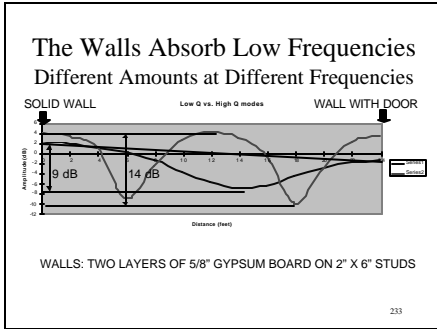

If a room surface absorbs sound, it will do so differently at different frequencies. It is the nature of such surfaces to slightly alter the timing of the reflected sounds (phase shift) depending on the frequency of the sound relative to the preferred frequency for the absorbing surface.

A real world example of this is shown here. It was noted that one wall of a room was vibrating quite actively. The wall had a door in it, and it appeared that this reduced the structural stiffness, allowing much more movement than the other walls. Out of interest, we measured the pressure distribution across the room for the first two modes. The first order mode had more damping than the second.

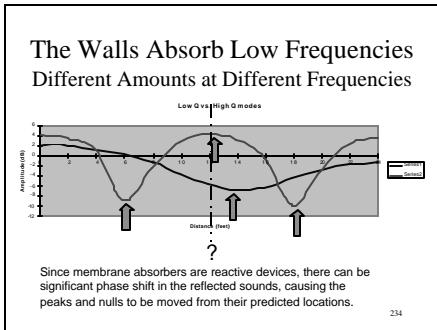

This is seen as a lower maximum-to-minimum pressure variation – 9 dB for the first-order mode vs. 14 dB for the second. Also apparent was a positional shift of the high and low pressure points. They were not exactly at the locations simple mathematics would predict. The null of the first order mode was substantially off center, towards the wall with the door.

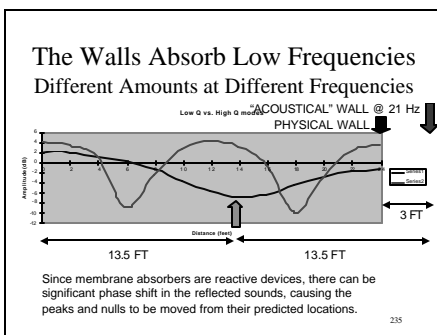

I made the simple assumption that most of the absorption was occurring in the wall with the door, and speculated that the phase shift in the absorbing wall was making it look (acoustically) as though it was farther away. On this basis, I took the distance from the “solid” wall to the null to be the true 1/4 wavelength, and projected the same distance towards the wall with the door. This put the “acoustical” wall three feet away from the real one! Acoustically, at this frequency, the room was behaving as if it were three feet longer than the physical length.

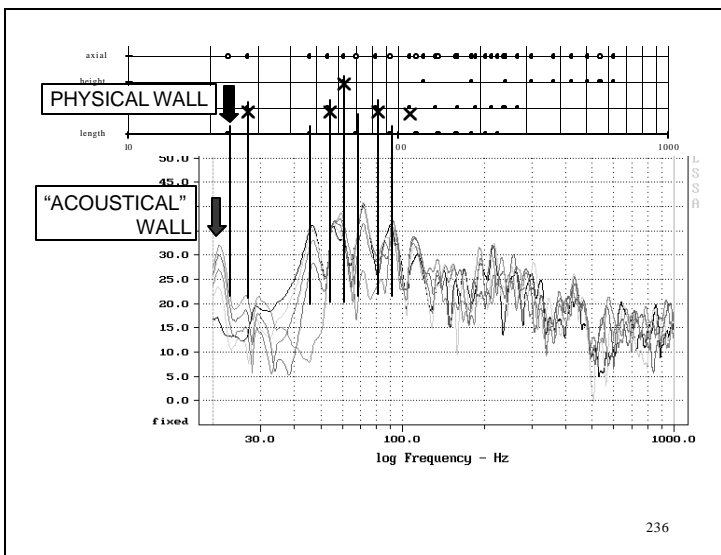

If this is true, then the frequency of the first-order resonance must not be at the frequency predicted by a measurement of the room length, but at a frequency appropriate for a room three feet longer.

This graph shows that this is so. At the frequency calculated for this mode based on the room dimensions, there is no resonant peak. However, at a frequency appropriate to a room three feet longer, there is a healthy resonant peak.

This explains why, very often, it will be found that the measured resonances do not exactly correspond with the calculated ones. This is also why room acoustical modeling programs do not always give the right answers. In rooms it is essential to make high-resolution, accurate, measurements in the room after it is built.

Room Walls Perform Two Key Tasks

- Provide transmission loss to prevent inside sounds from leaking into the rest of the house, and outside sounds from leaking into the listening space.
- Provide absorption to damp the low-frequency room resonances.

Conclusion: we need two kinds of wall in one.

237

Sound transmission loss in a wall is a measure of how well it prevents sound from traveling through it. Absorption coefficient is a measure of what proportion of the sound falling on a surface is absorbed, and not reflected back into the room. They are two very different things, and they are often confused. Most studies of transmission loss were concerned with privacy, and focused on speech frequencies, not paying much attention to low bass frequencies. With today's powerful woofers and subwoofers, we need new and higher standards.

For Example:

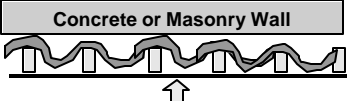

Concrete or Masonry Wall

One layer of gypsum wallboard on wooden studs, with fiberglass.

238

Here the massive, stiff, concrete is providing the bulk of the sound isolation. The standard stud wall provides some attenuation, as well as some sound absorption. Its vibrations are isolated from the concrete wall by an air space and, at low frequencies, the larger the better. Some fiberglass in the cavity adds to the effectiveness by damping reverberation in the space between the walls, not by actually preventing sound from passing through it.

Or . . .

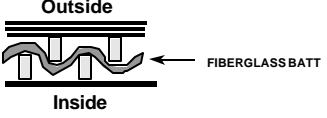

Outside

Inside

FIBERGLASS BATT

239

Here is another dual-purpose wall, with multiple layers of gypsum board substituted for the concrete. Again a large part of the isolation is due to the mechanical separation between the inner "microphone" wall and the outer "loudspeaker" wall. If the walls are connected, the "microphone" talks directly to the "loudspeaker" and there is almost no sound attenuation. Therefore, these walls must not be mechanically connected at any point – no conduits, no water pipes, nothing to link the inner and outer walls. HVAC penetrations must be flexible, and be equipped with special acoustical absorbers on each side of the wall to prevent sound leakage through the duct itself.

Or . . .



Fabricated or purchased membrane absorbers

240

If acoustical isolation is absolutely paramount, then there is little choice but to go for broke. Build a really massive double wall, and then add membrane absorbers on the inner surface. Always remember that low-frequency isolation can be defeated by even quite small air leaks. Keep an eye on the builder, and be sure that all joints are caulked, and that no penetrations or mechanical short circuits have crept in.

Or . . .

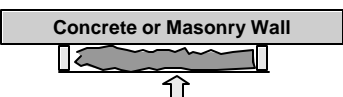

Concrete or Masonry Wall

Fabricated or purchased membrane absorbers

241

A membrane absorber can be considered a mechanically resonant panel absorber. Another type of low-frequency absorber is the acoustically resonant absorber, also known as the Helmholtz absorber. In these devices, one or a few large openings, or many small openings, resonate with a volume of air at the appropriate frequency. These require careful design, and careful construction, but can work very well.

The MOST PROBLEMATIC rooms I have ever encountered are those that have been constructed with massive, stiff walls.

They have:

1. High Q resonances that ring
2. Poor bass uniformity over the listening area.

242

It is truly sad when someone has spent good money building a room of “solid” walls, based on the belief that it keeps the bass in. Yup, it sure does, but it makes that bass unpleasant to listen to. To those who suggest that thumping a wall with a fist is a useful test of a wall, I will say that it is about as useful as the knuckle test is of a loudspeaker enclosure. Both are highly unreliable because sound waves energize room walls and loudspeaker enclosures very differently than fists or knuckles.

The Rules for Good Sound in Rooms

At middle and high frequencies:

- ✓ Start with a loudspeaker that was designed to function well in a variety of different rooms.
- ✓ Use geometry, reflection, diffusion, and absorption to achieve good imaging and ambiance.

At low frequencies:

- ✓ Maximize the output from the subwoofer(s).
- ✓ Achieve a uniform performance over the listening area.

➤ Equalize to achieve good performance.

243

So, we have done what we can to achieve uniform sound quality over the listening area. Now we will attempt to make it sound good by using equalization.

Equalization! You thought that it didn’t really work. That equalizers added phase shift and other ugly stuff.

Historically, equalization has not lived up to its promise. However, we have learned what it can and cannot do. We now understand why, the way it has been traditionally done, equalization we doomed to disappoint.

The key to “intelligent” room equalization is in knowing what can and cannot be corrected with filters.

245

Remember room resonances, those things that cause “boom” , “hangover” , “ringing” , “coloration”, and that mask our ability to follow bass melodies. They behave as minimum-phase phenomena, and they can be equalized if the measurements have enough resolution to show the details of what is happening, and if they resonances are addressed with carefully matched parametric equalizers.

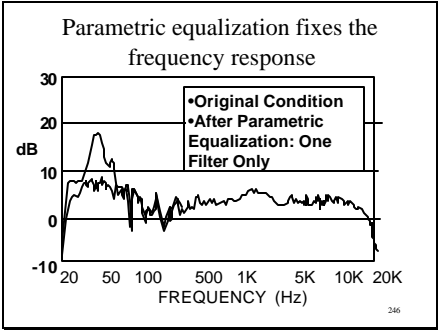

Here is a room with a really **big** boom. I am familiar with this one, as it was in my last house. It was where I began experimenting with selective parametric equalization, as an alternative to moving the furniture around or engaging in massive reconstruction.

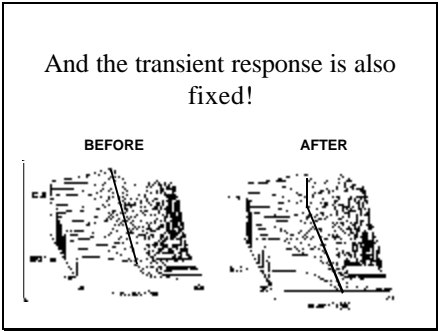

And it really works. Kick drums that previously boomed relentlessly, became “quick” and “tight”, and bass guitarists could actually be heard playing harmonies. Organ pedal notes were all there in proper proportions. An amazing transformation.

It doesn’t work everywhere in the room, but nothing does. Those pesky standing waves are still there. They will not go away.

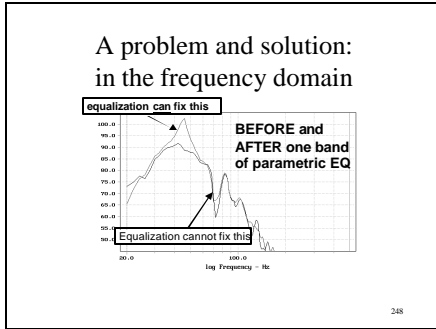

This is one I showed earlier, pointing out what can and cannot be equalized.

Dips are caused by acoustical cancellations

- The problem is *very* position sensitive – it will be different at different positions in the room. In fact that leads us to the solution: move the speaker, the listener, or both. A few inches may be sufficient.
- Trying to fill the dip is foolish! A 10 dB boost uses 10x more power! A 20 dB boost uses 100x more power! You have just added a 10 or 20 dB resonance that will be clearly audible at most locations other than the one at issue.

249

And this is why.

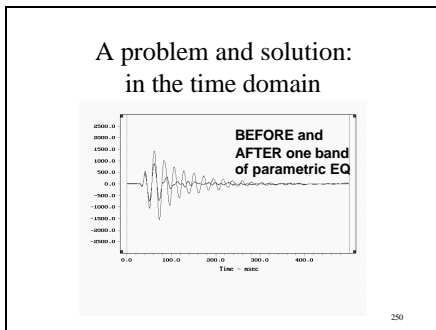

Just to confirm that our ears weren't lying to us, the time-domain measurement shows that the extended ringing of the original room is tamed.

So, equalization can work!

- If you have high resolution measurements
- If you try to fix the right things
- If you have a parametric filter that you can tune to match the problem.

But, what happens if you don't?

251

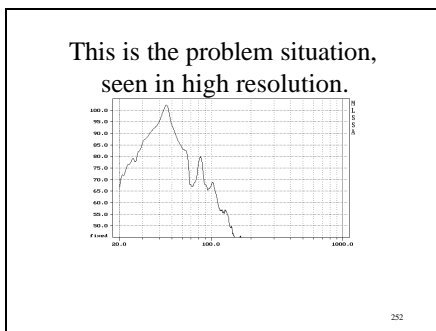

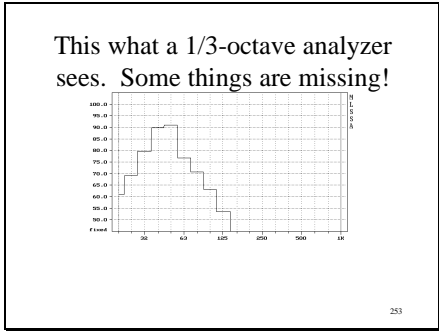

It is amazing that so much information could just slip away so easily.

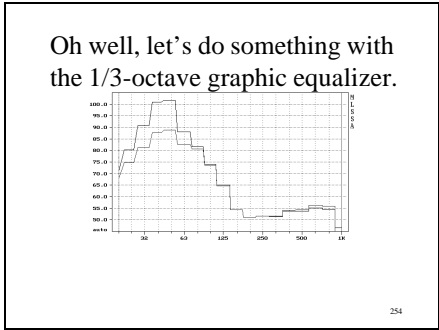

However, we do have a “graphic” equalizer, so we had better do something with it. [A “graphic” equalizer is the one with a large collection of fixed-bandwidth filters, adjusted using a collection of sliders on the front panel].

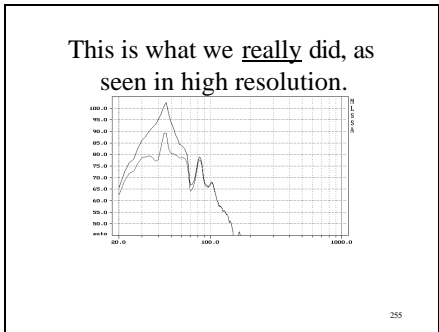

When it was done, the customer complained that the bass level was lower, and it still was boomy. This is why. When we look at things with the clarity of high-resolution measurements we see what happened. The crude measurement did not show the true situation, and the crude equalizer could not address it even if we could see it.

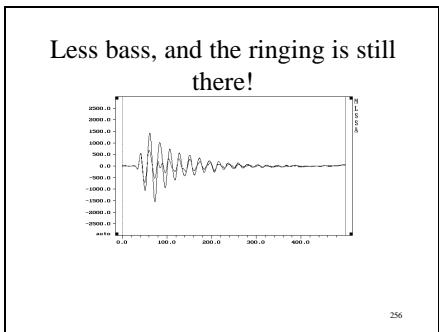

And, yes, the time domain was still corrupted, because the frequency domain was still corrupted.

It is no wonder that equalization has acquired a bad reputation. It deserves it!

257

Bass Equalization can work!

- If it is based on accurate high resolution measurements - i.e. not simplistic 1/3-octave real-time analyzer data.
- If the equalization addresses the room resonance problems with accurately matched parametric filters - not the simplistic 1/3-octave multfilter devices.
- If you do not try to fill dips caused by acoustical cancellations. It is impossible.

288

To see what is happening at low frequencies, analyzers must have resolution of 1/10 octave or better.

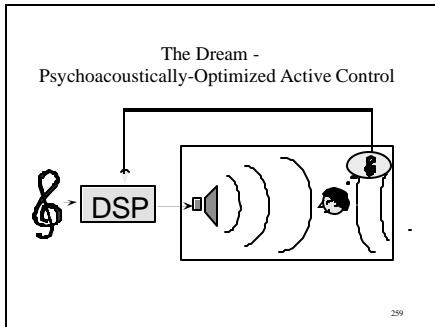

289

One day we will be able to have all of this done automatically and 'perceptually correct'. The holdup is partly cost, and partly the development of the measurement and equalization methodology that is smart enough to know what is wrong and what it should and should not try to fix. It has to be foolproof.

Sadly, equalization cannot fix everything. Some problems will remain stubbornly in the acoustical domain, so there will be a continuing role for people who understand room acoustics, and who provide the all-important final link to the customers' satisfaction.

Some relevant scientific publications by staff of the Harman International R&D Group (F.E. Toole, S.E. Olive)

1. F.E. Toole, "Listening Tests, Turning Opinion Into Fact", J. Audio Eng. Soc., vol. 30, pp. 431-445 (1982 June).
2. F.E. Toole, "The Acoustics and Psychoacoustics of Headphones", 2nd International Conference, Audio Eng. Soc. , preprint C1006 (1984 May).
3. F.E. Toole, "Subjective Measurements of Loudspeaker Sound Quality and Listener Performance", J. Audio Eng. Soc., vol 33, pp. 2-32 (1985 January/February)
4. **F.E. Toole, "Loudspeaker Measurements and Their Relationship to Listener Preferences", J. Audio Eng, Soc., vol. 34, pt.1 pp.227-235 (1986 April), pt. 2, pp. 323-348 (1986 May).
5. **F.E. Toole and S.E. Olive, "The Modification of Timbre by Resonances: Perception and Measurement", J. Audio Eng, Soc., vol. 36, pp. 122-142 (1988 March).
6. F.E. Toole, "Principles of Sound and Hearing", in K.B. Benson, ed. "Audio Engineering Handbook", chap. 1 (McGraw-Hill, New York, 1988).
7. S.E. Olive and F.E. Toole, "The Detection of Reflections in Typical Rooms", J. Audio Eng, Soc., vol. 37, pp. 539-553 (1989 July/August).
8. S.E. Olive and F.E. Toole, "The Evaluation of Microphones - Part1: Measurements", 87th Convention, Audio Eng, Soc., preprint no. 2837 (1989 October).
9. F.E. Toole, "Listening Tests - Identifying and Controlling the Variables", Proceedings of the 8th International Conference, Audio Eng, Soc. (1990 May).
10. F.E. Toole, "Loudspeakers and Rooms for Stereophonic Sound Reproduction", Proceedings of the 8th International Conference, Audio Eng, Soc. (1990 May).
11. S.E. Olive, "The Preservation of Timbre", Proceedings of the 8th International Conference, Audio Eng, Soc. (1990 May).
12. F.E. Toole, "Binaural Record/Reproduction Systems and Their Use in Psychoacoustic Investigations", 91st Convention, Audio Eng, Soc., preprint no. 3179. (1991 October).

13. P. Schuck, S. Olive, E. Verreault, M. Bonneville, S. Sally "On the Use of Parametric Spectrum Analysis for High-Resolution, Low-Frequency, Free-Field Loudspeaker Measurements", 11th Int. Conference, Audio Eng. Soc. (1992 May).
14. P. L. Schuck, S. Olive, J. Ryan, F. E. Toole, S Sally, M. Bonneville, E. Verreault, Kathy Momtahan, "Perception of Reproduced Sound in Rooms: Some Results from the Athena Project", pp.49-73, Proceedings of the 12th International Conference, Audio Eng. Soc. (1993 June).
15. F.E. Toole, "Subjective Evaluation", in J. Borwick, ed. "Loudspeaker and Headphone Handbook - Edition", chap. 11 (Focal Press, London, 1994).
16. **S.E. Olive, P. Schuck, S. Sally, M. Bonneville, "The Effects of Loudspeaker Placement on Listener Preference Ratings", J. Audio Eng. Soc., Vol. 42, pp. 651-669 (1994 September).
17. F.E. Toole and S.E. Olive, "Hearing is Believing vs. Believing is Hearing: Blind vs. Sighted Listening Tests and Other Interesting Things", 97th Convention, Audio Eng. Soc., Preprint No. 3894 (1994 Nov.).
18. S. E. Olive, "A Method for Training of Listeners and Selecting Program Material for Listening Tests", 97th Convention, Audio Eng. Soc., Preprint No. 3893 (1994 November).
19. S.E. Olive, "Separating Fact From Fiction Through Listening Tests", proceedings of the 1995 DSPx Technical Program, pp. 454-463, (1995 May).
20. F.E Toole and S.E. Olive, "Listening Test Methods for Computer Workstation Audio Systems", 99th Convention, Audio Eng. Soc., No Preprint (1995).

21. S.E. Olive, P. Schuck, J. Ryan, S. Sally, M. Bonneville, "The Variability of Loudspeaker Sound Quality Among Four Domestic-Sized Rooms", presented at the 99th AES Convention, preprint 4092 K-1 (1995 October).
22. S. E. Olive, "A Method for Training Listeners: Part II –", presented at the 101st Convention, Audio Eng. Soc., (no preprint), abstract published in J. AES Vol. 44, No. 12 (1996 Dec.).
23. S.E. Olive, P. Schuck, J. Ryan, S. Sally, M. Bonneville, "The Detection Thresholds of Resonances at Low Frequencies", J. AES Vol. 45, No. 3 (1997 March.).
24. F.E. Toole, "The Future of Stereo", Part 1, Audio, Vol.81, No.5, pp. 126-142 (1997, May), Part 2, Audio, Vol. 8, No. 6, pp. 34-39 (1997 June).
25. F.E. Toole, "The Acoustics and Psychoacoustics of Workstation Audio Systems", 16th International Congress on Acoustics and 135th Meeting of the Acoustical Society of America, Seattle, WA, Session 4pSP, (1998 June).
26. S.E. Olive, B. Castro and F.E. Toole, "A New Laboratory For Evaluating Multichannel Systems and Audio Components", 105th Convention, Audio Eng. Soc., preprint no. 4842 (1998 Sept).
27. S.E. Olive, "Subjective Evaluation of 3-D Sound Based on Two Loudspeakers", Proceeding of the 15th International Conference, Audio Eng. Soc. (1998 Oct.).
28. S.E. Olive, B. Castro and F.E. Toole, "A New Laboratory and Methodology for the Subjective Evaluation of Workstation Audio Systems" presented at the 106th Convention, Audio Eng. Soc., Munich, (1999 May).
29. F.E.Toole, "The Acoustics and Psychoacoustics of Loudspeakers and Rooms – The Stereo Past and the Multichannel Future", an invited paper at the 109th Convention, Audio Eng. Soc., Preprint no. 5201 (2000 Sept.).
30. S.E. Olive, "A New Listener Training Software Application", 110th Convention, Audio Eng. Soc., Preprint no. 5384 (2001 May).
31. S.E. Olive, "Evaluation of Five Commercial Stereo Enhancement 3D Audio Software Plug-ins", 110th Convention, Audio Eng. Soc., Preprint no. 5386 (2001 May).
32. F.E. Toole and S.E. Olive, "Subjective Evaluation", in J. Borwick, ed. "Loudspeaker and Headphone Handbook - Third Edition", (Focal Press, London, 2001).
33. F.E. Toole, "Sound Reproducing Systems", in McGraw-Hill Encyclopedia of Science and Technology, ninth edition, in press.

**** For these papers the authors received Audio Engineering Society Publications Awards
In 1996 Floyd Toole was awarded the AES Silver Medal “for significant developments in
the subjective and objective evaluation of audio devices”.**

**For some lighter reading: go to www.harman.com . Look under
“white papers”.**

Useful References:

“The Master Handbook of Acoustics”, Fourth Edition, by F. Alton Everest
McGraw-Hill, 2001

This comprehensive, and readable text goes beyond the normal “handbook” formula, and tries to give the reader some understanding of why things happen. For those interested in low-frequency absorbers, there are several helpful sections.

“Loudspeaker and Headphone Handbook”, Third Edition, edited by John Borwick.
Focal Press, 2001

Is there a definitive book on this subject? This may be it. Up to date and loaded with detailed engineering level information.