

# REMOTE CONTROL PRESENTATION

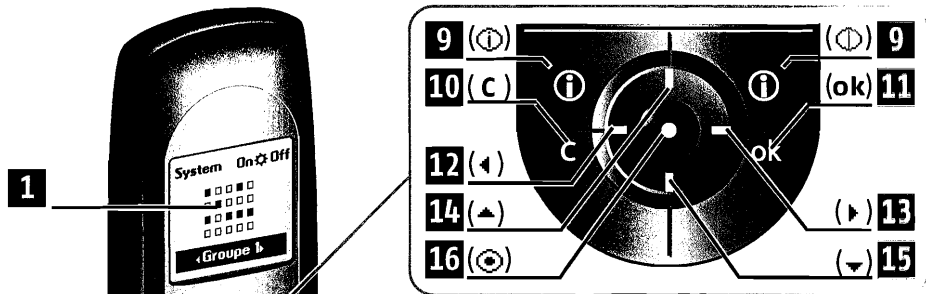

- 2 (↑)
- 3 (my)
- 4 (↓)

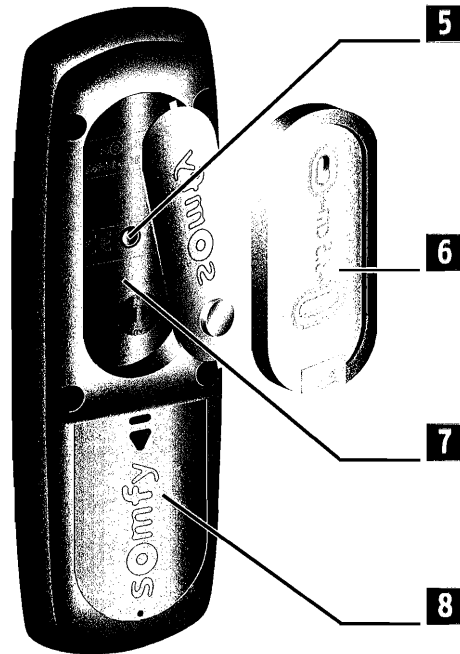

## Description of the remote control

- 1 Display
- 2 Up order (↑)
- 3 Stop / Intermediate position (my)
- 4 Down order (↓)
- 5 Programming key (Prog.)
- 6 Wall mount
- 7 Mount compartment
- 8 Battery compartment cover
- 9 Help / Information (i)
- 10 Cancel or back to a previous screen (C)
- 11 Validation (ok)
- 12 Move left (←)
- 13 Move right (→)
- 14 Move up (▲)
- 15 Move down (▼)
- 16 Selection key (⊙)

## Description of the symbols used in Telis Composio menus:

### Menus

- 17 Groups (■)
- 18 Solar sensors (→\*)
- 19 Settings (⚙)

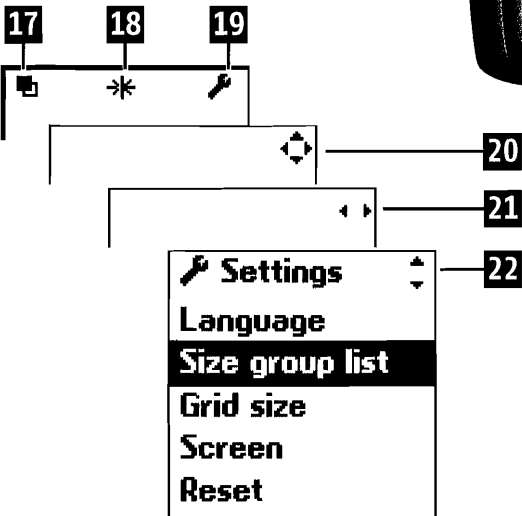

Symbols 20, 21 and 22 indicate the ability to move within the screen in the direction shown by the arrows to access other set up elements not visible on-screen.

## CHARACTERISTICS

### Presentation

Telis Composio RTS is a remote control that lets you drive up to 20 groups of products compatible with Somfy (RTS) radio technology.

The following product categories can be controlled by the Telis Composio RTS remote control:

- roller shutters,
- terrace awnings
- blinds (roller or pleated),
- venetian blinds (interior or exterior),
- garage doors and gates,
- lights (with a suitable radio receiver).

Available at [www.AV-Outlet.com](http://www.AV-Outlet.com)

### Technical specifications

#### Dimensions

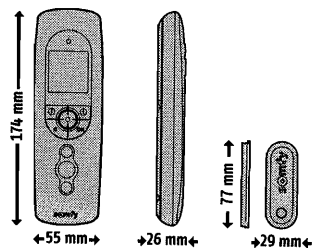

#### Operating temperature

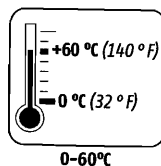

#### Protection level



#### Radio range

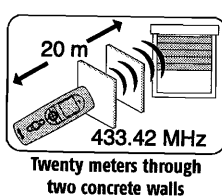

## SETTING INTO SERVICE

### Fitting/replacing batteries

Open the battery compartment cover. Insert three brand new type AAA (LR03) 1.5 V alkaline batteries from the same source and with the same expiry date.

Be sure to comply with the polarity indications shown on the remote control.

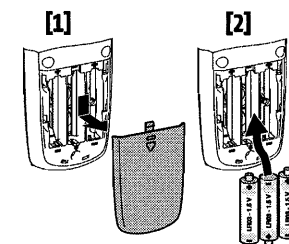

### Never use rechargeable batteries.

A low battery condition is shown on the display by the (  ) symbol.



All programmed settings remain in memory when the batteries are replaced or if they become completely discharged.

If the remote control is not to be used for an extended period, we recommend removing the batteries.

Used batteries should always be recycled and never disposed of with regular waste .

### Setting into service for the first time

When first used the Telis Composio RTS automatically prompts the user to set the language and create the first groups:

1- Select the language using the (  ) (  ) keys and confirm with (  ).

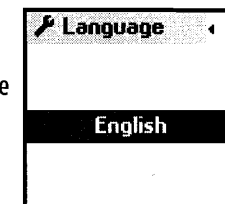

2- Start to create the groups (refer to "**Creating a group**").

• To create groups later, return to the main screen by pressing (  ) as many times as necessary.

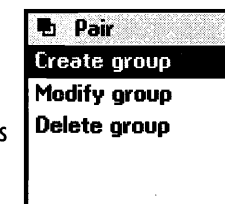

### Attaching the wall mount

#### Choosing a location for the wall mount

Choose an accessible location where it is easy to see and use the remote control.

Attach the wall mount to the wall using the two screws supplied. Attach it at a convenient height for reading the display.

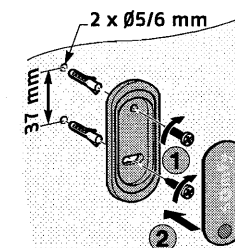

## QUICK START GUIDE

### Introduction

Telis Composio RTS is used to control all of the opening and closing systems for a home by creating groups of motor-driven systems to cover zones within the house. With just one touch of a key, all of the products in the same group will rise, fall or adopt a favourite position, simultaneously.

A group may comprise a number of products... or just one. You choose!

### Examples:

A single group for all of the ground floor shutter that will close them simultaneously to leave the house secure, even for a short while.

This group could be called "**Ground**".

Another group for all of the blinds on the South side of the house that will be closed to protect furniture and rugs from the afternoon sun during the summer months.

This group could be called "**South**".

Another group for all of the house blinds to close them at the touch of a key at bedtime.

This group could be called "**All blinds**".

Another group solely for the office window blind that will take up the ideal position to avoid any reflections off the computer screen.

This group could be called "**Office**".

Another group for the gate to open it for visiting friends.

This group could be called "**Gate**".

Telis Composio RTS offers the ability to create 20 different groups to organise house functions as needed.

Every group can be named and positioned as required.

## QUICK START GUIDE

### Moving through the matrix/menus

The (←) keys let you move the cursor to select a group or to access the menus and submenus provided by Tells Composio RTS.

Press (⊙) or (ok) to call up the next screen.

( C ) returns you to the previous screen. Press ( C ) as many times as necessary to return to the main screen.

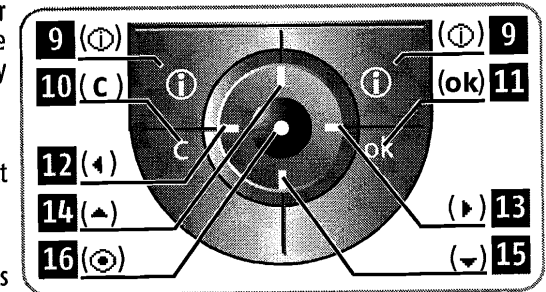

As a rule, (⊙) lets you choose the element that the cursor is pointing to and (ok) confirms an action.

### System menu general layout

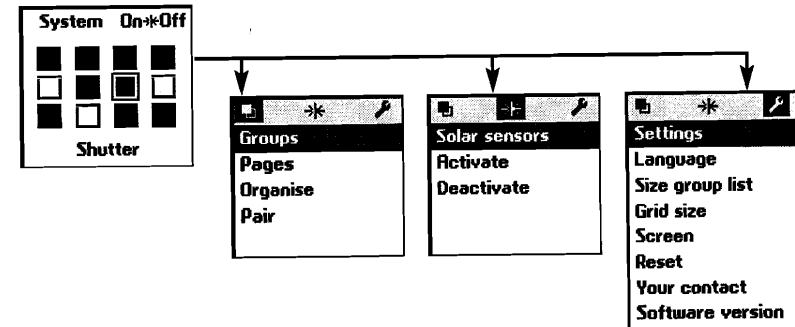

## QUICK START GUIDE

### Selecting a group

There are two different ways to select a group.

#### Selecting a group by name

Place the cursor on the group names at the bottom of the screen and use the (← →) keys to scroll the group names until the desired group is found.

The names that appear in this field are the names of the last groups used. You can choose to display the last five groups used, the last ten groups used or all groups. This setting can be modified from the "System > Settings > Size group list" menu (refer to "Settings").

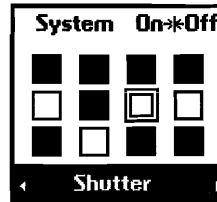

#### TIP

- Setting up this function so that it only displays the last five groups used makes it possible to run a quick search on the most used groups.

#### Selecting a group from the matrix

Select the desired group directly from the matrix using the (↕) keys. The black boxes correspond to groups that have already been created; the blank boxes correspond to blank locations.

The corresponding group name is displayed at the bottom of the screen.

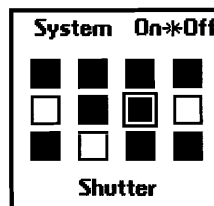

### Driving a group

After first selecting a group, all of the products in the group can be driven simultaneously:

#### Up order

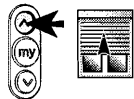

#### Down order

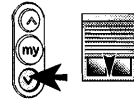

#### Stop a moving group

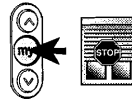

Garage door and gate opening and closing systems are driven in sequential mode using the (my) key: every time you press the (my) key, the drive motor successively receives the up / stop / down / up / stop orders...

Garage door and gate opening and closing systems must not therefore be included in groups comprising other kinds of products that use a conventional drive mode. A group should be created for each garage door or gate opening and closing system. Garage doors and gates must always be operated when in sight of the user.

## QUICK START GUIDE

### Favourite position

An intermediate "favourite position (my)", that is not the up or down position, can be defined for each of the following product types:

Favourite position	Roller shutters	Blinds (terrace awning or roller blinds)	Venetian blinds (indoor or outdoor)	Garage doors and gates	Lights (with a suitable radio receiver)
YES	●	●	●		●
NO				●	

#### Examples:

- For the roller shutter on a bedroom window, the favourite position may not correspond to fully closed, instead it may be so that light can be seen between the laths.
- For the roller shutters on the living room windows, the favourite position may be the one that casts a shadow on a particular point in the room (TV screen, plant, rug, etc.).
- For the terrace awning, the position that puts the door or window in the shade.

#### Use

Once a group of products has been stopped, whatever their position, pressing the (my) key will move all of the selected group products to their respective favourite positions.

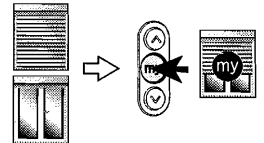

We recommend saving, modifying or deleting favourite positions individually for each product:

- using Telis Compositio RTS for groups comprising a single product.
- using the product's local control point.

### Saving or modifying the favourite position

Move the product to the desired position.

To save the position, press the (my) key until the product confirms that it has stored the favourite position with a brief move (for approximately five seconds).

The favourite position is saved.

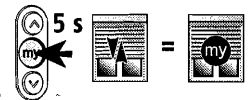

### Deleting the favourite position

Press the (my) key when the product is stopped so that it will find its favourite position.

Once the product is in its favourite position, press the (my) key until the product confirms that it has deleted the favourite position with a brief movement (for approximately five seconds).



View the animated instructions for use and print off these instructions from the web site at: [www.mysomfy.com](http://www.mysomfy.com)

## QUICK START GUIDE

### Using the Soliris (\* ) function

The Soliris function lets you enable or disable the solar sensors on one or more groups of products.

Select **"On"** or **"Off"** to enable or disable the Soliris function and confirm with (  ) or ( **ok** ).

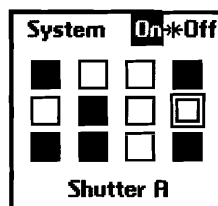

This function can also be accessed from the **"System > Solar sensors"** menu.

### Choose the appropriate option:

**"Choose groups"** to select the one or more groups for which to activate or deactivate the Soliris function. Select which groups to include using (  ). Confirm with ( **ok** ).

**"Final selection"** to activate or deactivate the Soliris function on the one or more last groups on which the function was activated or deactivated. This selection can be modified by adding or deleting groups using (  ). Confirm with ( **ok** ).

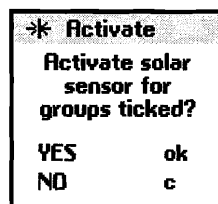
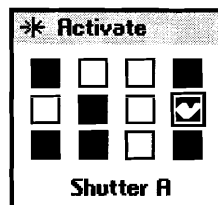
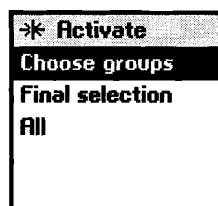

**"All"** to activate or deactivate the Soliris function for all of the groups controlled by the Telis Composio RTS remote control. Using this selection it is also possible to delete groups with (  ). Confirm with ( **ok** ).

Confirm the operation with ( **ok** ).  
Cancel with ( **C** ).



## RENAME MATRIX

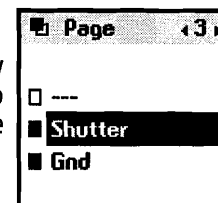

### Renaming groups

The **"System > Groups > Page"** (  ) menu lets you display groups column by column with their names. Select the desired group using the (  ) keys and confirm with (  ) or ( **ok** ) to rename the group.





- You can also access the **"System > Groups > Page"** menu directly from the matrix using (  ) or ( **ok** ).
- This display mode can also be used to drive groups.

### Using the name entry screen

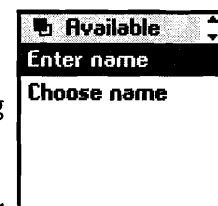
Choose a character using the arrow keys (  ) and validate by pressing (  ). The cancel key ( **C** ) lets you delete an incorrect character.



Select **"Xx"** and press (  ) to choose a character type: upper or lower case.



The arrow key (  ) lets you access accented characters.

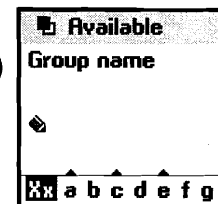

Once you have finished entering the name, validate with the ( **ok** ) key.



- The (  ) keys let you move from one line of characters to the next, faster.
- You can enter a new name in full using **"Enter name"** or from a preset, customisable list using **"Choose name"**.

### Organising groups in the matrix

From the **"System > Groups > Organise"** (  ) menu, select the group to move using (  ). The newly selected group is momentarily placed at the top of the screen.

Choose a new location using the (  ) keys and reposition the group in the desired location with (  ).

If the target location is already taken by another group, the latter will in turn be placed at the top of the screen while awaiting a new location.

Validate the modifications with ( **ok** ).

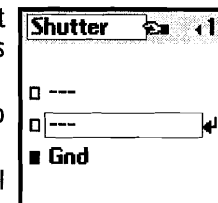

## SETTINGS

"System > Settings" menu (🔧).

### Language

Seven languages are offered by the Telis Composio RTS remote control: *French, English, German, Spanish, Italian, Portuguese, Dutch*. Select the language with the (← →) keys and validate the selection with (ok).



### Last groups used

"Size group list" lets you choose to display the last five groups used, the last ten groups used or all groups when searching for a group by name. Select the chosen option with (⊙) and confirm with (ok).

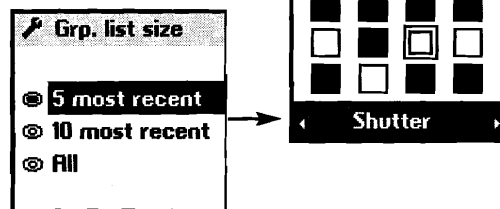

### Matrix size

The matrix can be set up for a 12 group display (3 lines x 4 columns) or a 20 group display (4 lines x 5 columns). The Telis Composio RTS remote control is factory set up for a 12 group display. Select the chosen option with (⊙) and confirm with (ok).

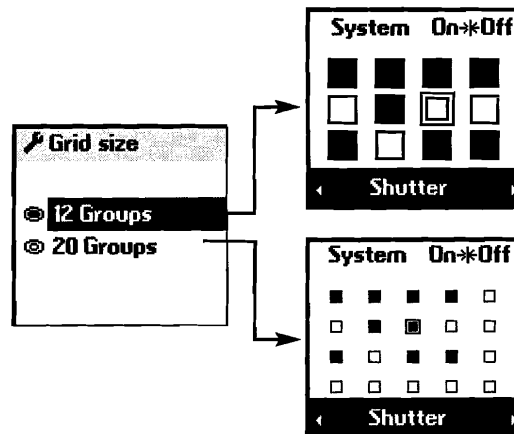

## SETTINGS

### Screen

The screen display can be set up without back lighting or with back lighting lasting 5 seconds or 15 seconds after the last key is pressed.

The Telis Composio RTS remote control is set up at the factory for 5 second back lighting. Select the chosen option with (⊙) and confirm with (ok).

### Reset

Resetting the Telis Composio RTS remote control returns it to the original factory set up. All of the groups created in the Telis Composio RTS remote control are retained after reset.

### Your contact

Use this location to find or record the contact information for your installation specialist.

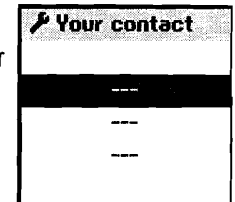

## CREATING A GROUP



We recommend pairing all carrier products with local control points and to set the end of travel stops for each carrier product before using the Telis Compositio RTS. Nevertheless, Telis Compositio RTS can be used like any RTS remote control to set motors into service (setting end of travel stops...).

The "**System > Groups > Pair**" (  ) menu lets you add, modify and delete groups.

### Creating a group

Select "**Create group**" and confirm with (  ) or ( **ok** ).

Select an available location to create a new group (blank boxes) and confirm with (  ) or ( **ok** ).

Each new group can be named by entering a name in full or by selecting one from a preset list of names (refer to "Customising the matrix" for more information on how the data entry screen works).

Once you have finished entering the name, confirm with ( **ok** ).

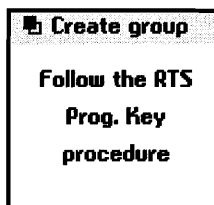
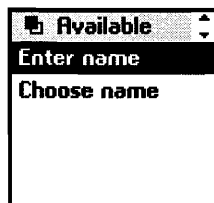
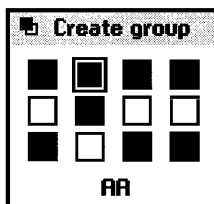
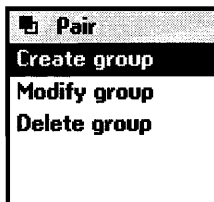

### The pairing procedure is performed as follows:

- 1- Press the ( **Prog.** ) key on the local control until the product moves briefly (a light receiver blinks): then you have two minutes left to perform the next step.

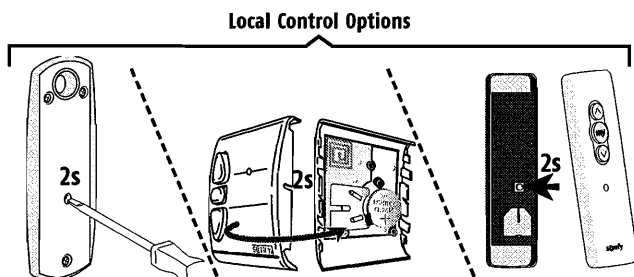

## CREATING A GROUP

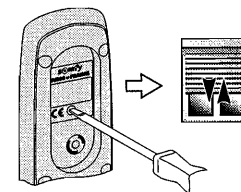

- 2- Press the ( **Prog.** ) key on the Telis Compositio RTS remote control for 0.5 seconds. The corresponding product is again activated (a brief movement or blinking) confirming the end of the procedure.



Repeat steps 1 and 2 for every product to be assigned to the group being created.

- 3- Once steps 1 and 2 have been completed for all of the products to be included in the group, finish the procedure by pressing ( **ok** ).



- 4- Test pairing using the (  ), (  ), (  ) keys. The product or products in the group will activate if the procedure was successful, if not, repeat steps 1 and 2. The group can be modified or deleted if necessary.

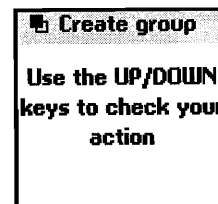

- 5- Finish with ( **ok** ) to validate.  
The blank box selected for creating the group becomes black.

### TIP

- Think about every day group use when creating them. A mixture of different applications in the same group may turn out to be not very handy in practice. For example, in a group comprising both roller shutters and the blind on the terrace, a down order will trigger the following result:
  - the roller shutters will roll down = closed
  - the blind on the terrace will roll down = open

## MODIFYING A GROUP

### Modifying a group

To add a product to a group or delete one, select "Modify group" and confirm with (⊙) or (ok).

From the matrix, select the group to modify and confirm with (⊙) or (ok).

The group modification procedure is performed as follows:

- 1- Press the (Prog.) key on the local control corresponding to the product to be added or deleted until brief product motion is observed (or blinking for a light receiver): then you have two minutes left to perform the next step.

Local Control Options

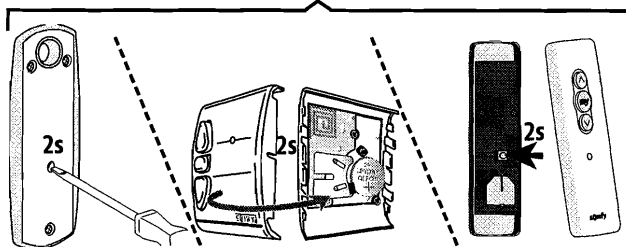

- 2- Press the (Prog.) key on the Telis Composio RTS remote control for 0.5 seconds. The corresponding product is again activated (a brief movement or blinking) confirming the end of the procedure.

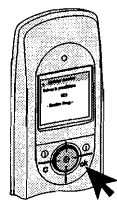

- 3- Finish the procedure by pressing (ok).

- 4- Test pairing using the (⊙), (⊕), (⊖) keys. The product should react if it has been added or no longer react if it has been deleted from the group. If not, repeat steps 1 and 2.

- 5- Finish with (ok) to validate.

• Repeat the procedure from the start ("System > Groups > Pairing > Modify group" menu) as many times as there are modifications to make.

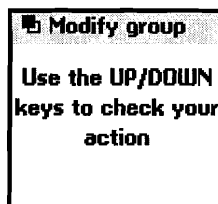
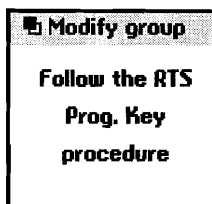
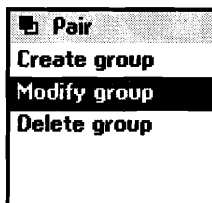

## DELETING A GROUP

### Deleting a group

To delete a group, select "Delete group" and confirm with (⊙) or (ok).

From the matrix, select the group to be deleted and confirm with (⊙) or (ok).

Delete all products from the group as follows:



All of the products in the group must be deleted individually, one after another.

- 1- Press the (Prog.) key on the local control corresponding to the product to be deleted until brief product motion is observed (or blinking for a light receiver): then you have two minutes left to perform the next step.

Local Control Options

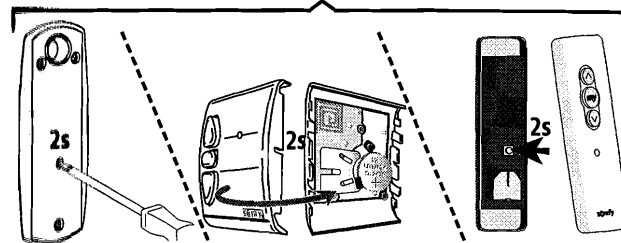

- 2- Press the (Prog.) key on the Telis Composio RTS remote control for 0.5 seconds. The corresponding product is again activated (a brief movement or blinking) confirming the end of the procedure.

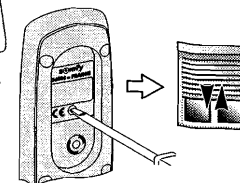

Repeat steps 1 and 2, if necessary, for all of the products to be deleted for the group currently being modified.

- 3- Delete all of the group products before finishing the procedure by pressing (ok).



- 4- Test pairing using the (⊙), (⊕), (⊖) keys. None of the products should react any longer. Repeat steps 1 and 2 if necessary and re-test pairing until all of the products in the group have indeed been deleted.

- 5- Finish with (ok) to validate.

The deleted group's box becomes blank once again.

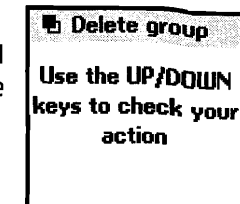

Only confirm with (ok) when none of the products react any more.